



CNP PUMPS INDIA PVT. LTD.

Plot No - B-5, TJSB House, 502, Sambhav IT Park,
Behind Aplab Company, Wagle Indi Estate,
MIDC, Thane - 400 604, India.

Tel : + 91 - 22 - 2581 8400 [100 lines]

E-Mail : sales@cnpindia.com

<http://www.sales@cnpindia.com>

MS/MSS

50Hz/60Hz

Light Stainless Steel Horizontal Single-stage Centrifugal Pump **2007**



E080202

The technical data are subject to amend without notice.



Company Profile



Hangzhou Nanfang Special Pump Industry Co.,Ltd. is specialized in manufacture of stainless steel multistage pumps, integrating scientific research, production and marketing. Since its establishment ten-odd years ago, the company has devoted considerable efforts to make innovation of technology and management, and has successfully developed various kinds of pumps which are applicable to industrial and mining enterprises, municipal water supply, farm irrigation, petrochemical engineering, domestic water and fire water supply of high buildings, industrial water treatment, water purification, pharmaceutical industry, boiler, air-conditioning system etc. The main performances of CDL series stainless multistage vertical pump, TD in-line circulation pump, SJ series stainless steel multistage deep-well submersible pump, CDLK, CDLKF immersion type multi-stage centrifugal pump, CHL/CHLK/CHLF series stainless multistage horizontal pumps and QY series stainless steel pump conveying mixed gas and liquid, ZS series stainless steel horizontal single-stage centrifugal pump, MS series light stainless steel horizontal single-stage centrifugal pump, have fully reached the international advanced level.

Besides advanced means used in design such as three-dimensional CAD and CFD software, the company boasts a complete set of precision manufacturing and inspection equipment. With perfect quality control system, the company has passed ISO9001 Quality System Certification, ISO14001 Environment Management System Certificate, and obtained CE Marking also. The products of the company sell well not only at home, but also in foreign countries in Europe, America, Southeastern Asia etc, gaining popularity due to their excellent quality, and good credit standing and considerate after-sales service of the company.

The company has established a wide sales and service network which has representative offices and service centers. Offices and service centers are set in all large and medium-scale cities, aiming to providing timely and satisfactory service for customers.

Satisfying customers will be eternal pursuit of the company. Looking forward to the future, the company will further keep up its fine tradition and persist in its business principle of "quality first, credit first and clients first" to offer customers products of high quality and more considerate services.

Nanfang pump, a national brand worthy of your trust!

Content

General Data

Definition of Model	3
Structure features	3
Application	3
Pumping liquids	4
Operating condition	4
Motor	4
Installation requirements	4
Curves	4
Scope of performance	5
Performance table	5
Section drawing	7
Material	7

Technical Data

MS60,50Hz	8
MS100,50Hz	9
MS160,50Hz	10
MS250,50Hz	11
MS330,50Hz	12
MSS100,60Hz	13
MSS160,60Hz	14
MSS250,60Hz	15
MSS330,60Hz	16
Installation sketch	17
Size and weight	17

● Definition of Model

MS250/1.5

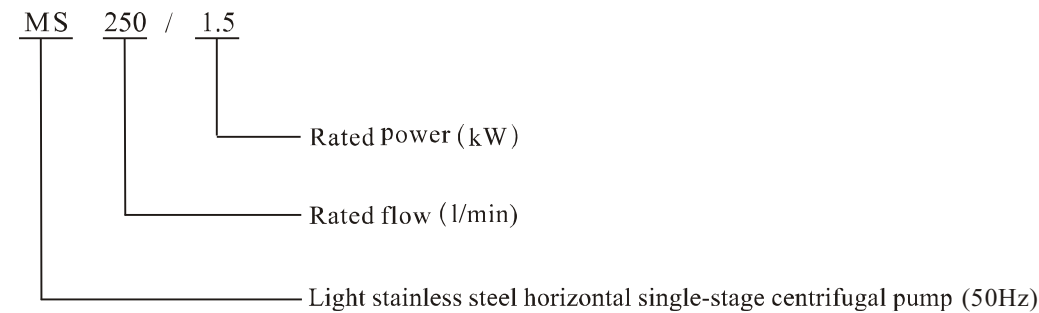

MSS250/1.5

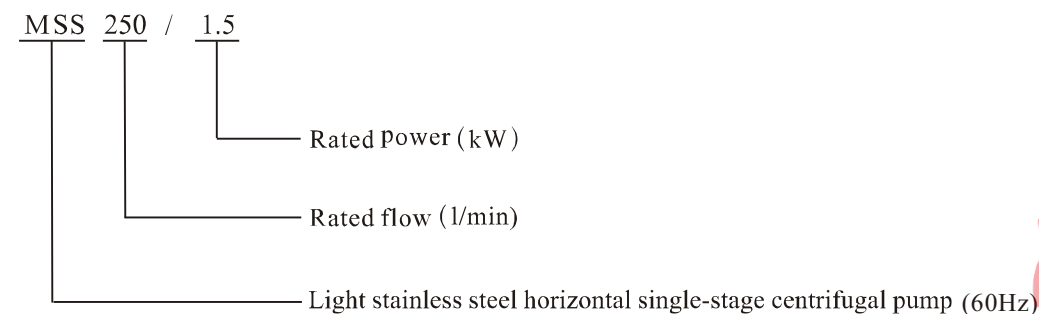

● Structure features

- MS/MSS series of pump is single-stage centrifugal pump and features axial suction and radial discharge;
- Compact structure, The pump is directly connected with the motor, coaxial installation;
- Convenient installation, screw thread water inlet and outlet;
- Light weight, thin plate pressing structure for main parts and components;
- Corrosion resistance, components passing the flow use AISI 304 or AISI 316 stainless steel.

● Application

- Pressurization and pumping of industrial and civilian clean water or other liquids;
- Water treatment ;
- Water circulating system;
- Agricultural irrigation;
- Other fields.

● Pumping liquids

- Thin, clean, non-flammable and explosive, not containing the liquid with solid particle and fiber;
- Able to transmit light corrosive medium (have a bearing on the content of chloride ion in the medium, thickness of acid or alkali, whether generate corrosion on the rubber and mechanical seal materials);
- The density of transmitted medium is less than that of clean water, viscosity close to that of water. Other wise the motor of large power is required.

● Operating condition

- Liquid temperature $-10^{\circ}\text{C} \sim +85^{\circ}\text{C}$;
- Ambient temperature: up to $+40^{\circ}\text{C}$;
- Altitude: up to 1000m;
- Max. pressure of the system is 8bar.

● Motor

- TEFC motor, 2-pole;
- Protection class: IP55;
- Insulation class :F;
- Standard voltage: 50Hz $1 \times 220\text{V}$
 $3 \times 380\text{V}/3 \times 220\text{V}$
- Standard voltage: 60Hz $1 \times 220\text{V}$
 $3 \times 380\text{V}/3 \times 220\text{V}$

● Installation requirements

- The pump shall be fastened on the stable horizontal base;
- The installation of the pump shall ensure that the pump will not be influenced by the tension of the pipeline;
- The pump shall be installed on the ventilating and anti-freezing place to ensure normal operation of the motor;
- Electric wiring device shall guarantee that the pump will not be damaged by lack of phase, unstable voltage, current leakage and overload.

● Curves

Include performance curve in the technical data:

- All curves are based on the measured values of 50Hz: constant motor speed 2850r/min, 60 Hz: constant motor speed 3450r/min;
- Measurement is done with 20°C air-free water, kinematic viscosity of $1\text{mm}^2/\text{sec}$;
- Curve tolerance in conformity with ISO9906 Annex A;
- The operation of pump shall refer to the performance region to prevent overload of motor due to too large flow rate.



● Scope of performance-50Hz

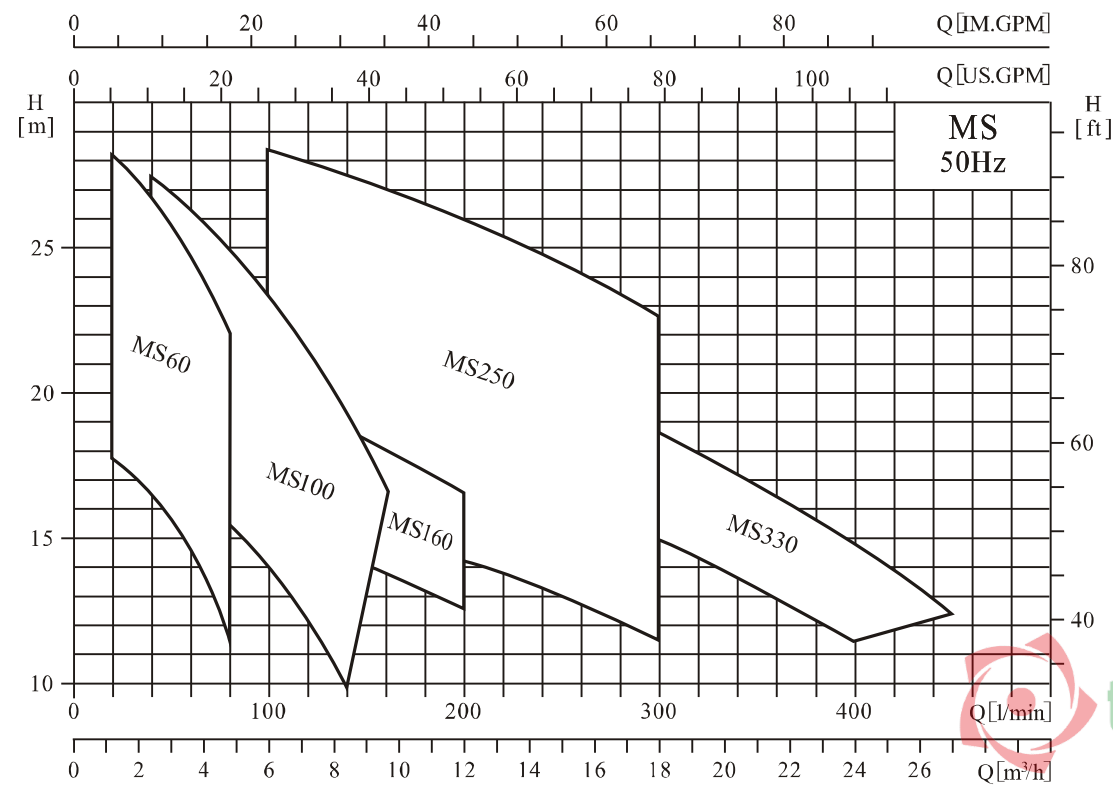

● Scope of performance-60Hz

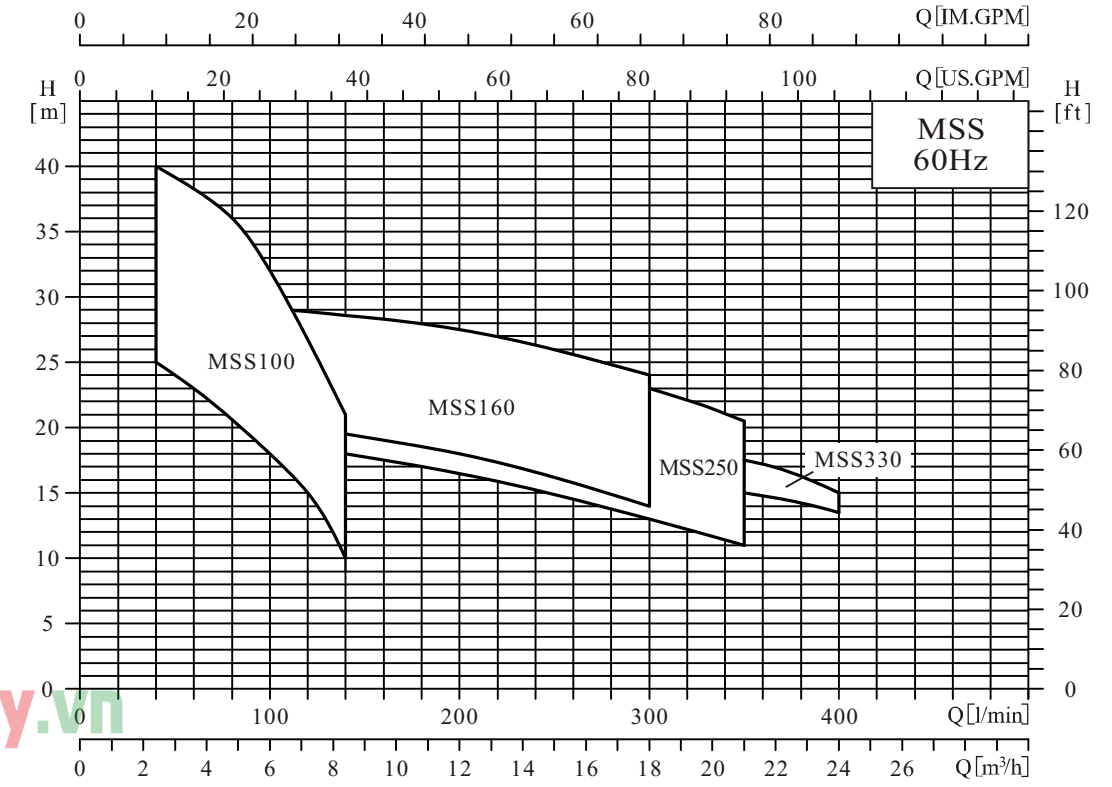

● Performance table

Model	Power (kW)	Q(l/min)	H (m)															
			20	40	60	80	100	120	140	160	200	250	300	330	350	400	450	
MS60/0.37	0.37	Q(m³/h)	1.2	2.4	3.6	4.8	6.0	7.2	8.4	9.6	12	15	18	20	21	24	27	
MS60/0.55	0.55		17.7	16.4	14.6	11.4												
MS60/0.75	0.75		22.7	21.3	19.5	16.2												
MS100/0.55	0.55		28.2	26.8	25	22												
MS100/1.1	1.1			17.8	16.7	15.4	14	12.2	9.9									
MS160/0.75	0.75			27.4	26.3	25	23.4	21.5	19.5	16.7								
MS160/1.1	1.1				15.5	15.3	15	14.8	14.3	13.8	12.5							
MS250/1.1	1.1				19.7	19.5	19.3	19.1	18.7	18.2	16.5							
MS250/1.5	1.5						15.8	15.6	15.4	15	14.3	13	11.5					
MS250/2.2	2.2						23.2	23	22.7	22.2	21.4	19.8	17.7					
MS330/1.5	1.5						28.2	27.8	27.5	27	26.2	24.6	22.6					
MS330/2.2	2.2							18.8	18.7	18.5	17.8	16.7	15	14	13.5	11.6		
								22.5	22.2	22	21.5	20.3	18.7	17.5	16.8	14.8	12.3	

● Performance table

Model	Power (kW)	Q(l/min)	H (m)															
			20	40	60	80	100	120	140	160	200	250	300	330	350	400		
MSS100/0.75	0.75	Q(m³/h)	1.2	2.4	3.6	4.8	6.0	7.2	8.4	9.6	12	15	18	20	21	24		
MSS100/1.1	1.1			25	23	21	17	15	10									
MSS100/1.5	1.5			33	31	29	25	21	15									
MSS160/1.1	1.1			40	38	36	32	27	22									
MSS160/1.5	1.5						20.5	20	19.5	19	18	17	14					
MSS160/2.2	2.2						25.5	25	24.5	24	23	22	20					
MSS250/1.1	1.1						29	28.8	28.5	28	27.5	26	24					
MSS250/1.5	1.5							18.5	18	17.5	16.5	15	13	12	11			
MSS250/2.2	2.2							22.5	22	21.5	20.5	18.5	16	14	13			
MSS330/1.5	1.5							28.5	28	27.5	26.5	25	23	21.5	20.5			
MSS330/2.2	2.2								19.5	19	18.5	18	16.5	16	15	13.5		
									23	22.5	22	20.5	19.5	18.5	17.5	15		

Section drawing

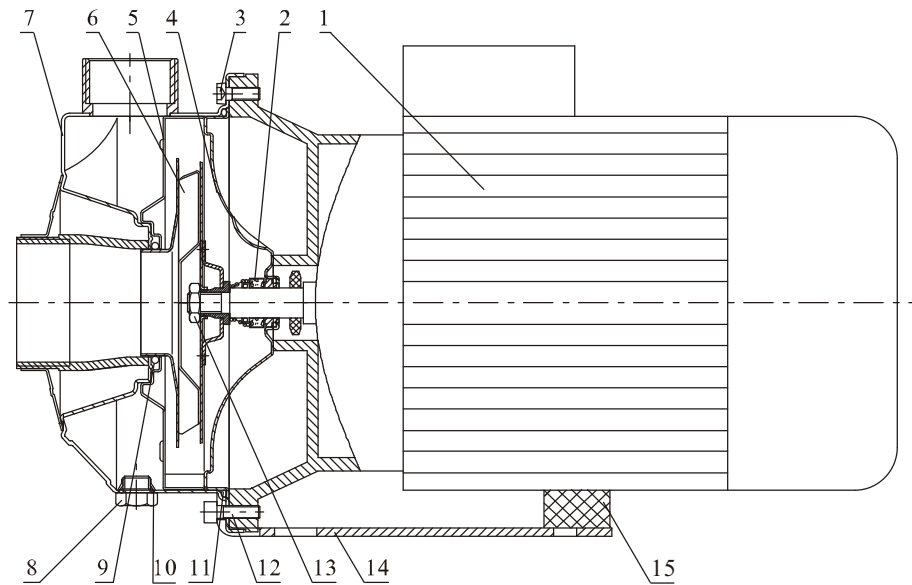

Performance curve

ISO9906 Annex A

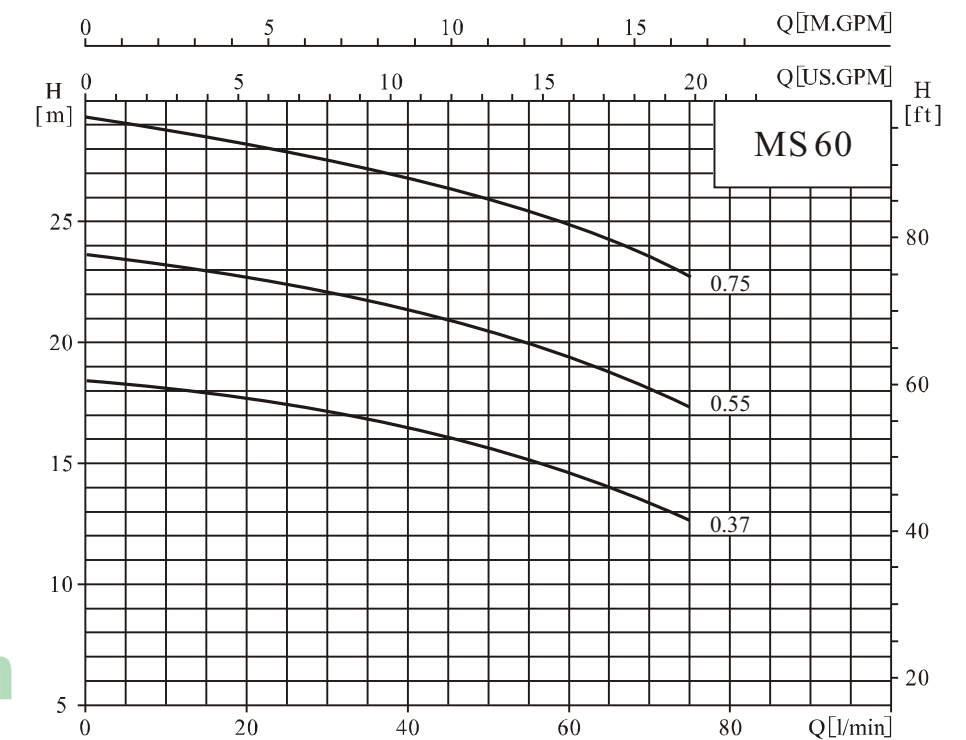

Material

NO.	Parts Name	Material	AISI
1	Motor		
2	Mechanical seal	Ceramic / Carbon	
3	M6 × 15 / Screw	0Cr18Ni9 / SS304	AISI304
4	Seal base	0Cr18Ni9 / SS304	AISI304
5	Diffuser	0Cr18Ni9 / SS304	AISI304
6	Impeller	0Cr18Ni9 / SS304	AISI304
7	Pump body	0Cr18Ni9 / SS304	AISI304
8	Vent	0Cr18Ni9 / SS304	AISI304
9	O-Ring	NBR	
10	O-Ring	NBR	
11	O-Ring	NBR	
12	M6 × 20 / Screw	0Cr18Ni9 / SS304	AISI304
13	Nut M10	0Cr18Ni9 / SS304	AISI304
14	Base	Steel	A570
15	Support foot	NBR	

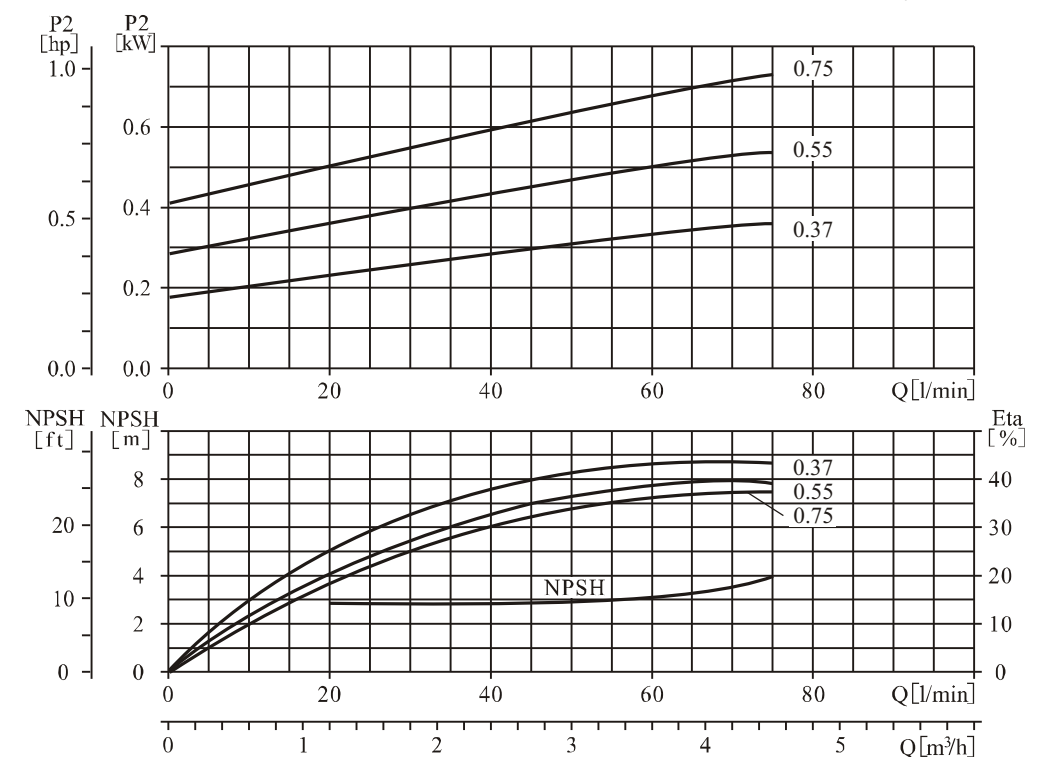

MS100,50Hz

MS160,50Hz

● Performance curve

ISO9906 Annex A

● Performance curve

ISO9906 Annex A

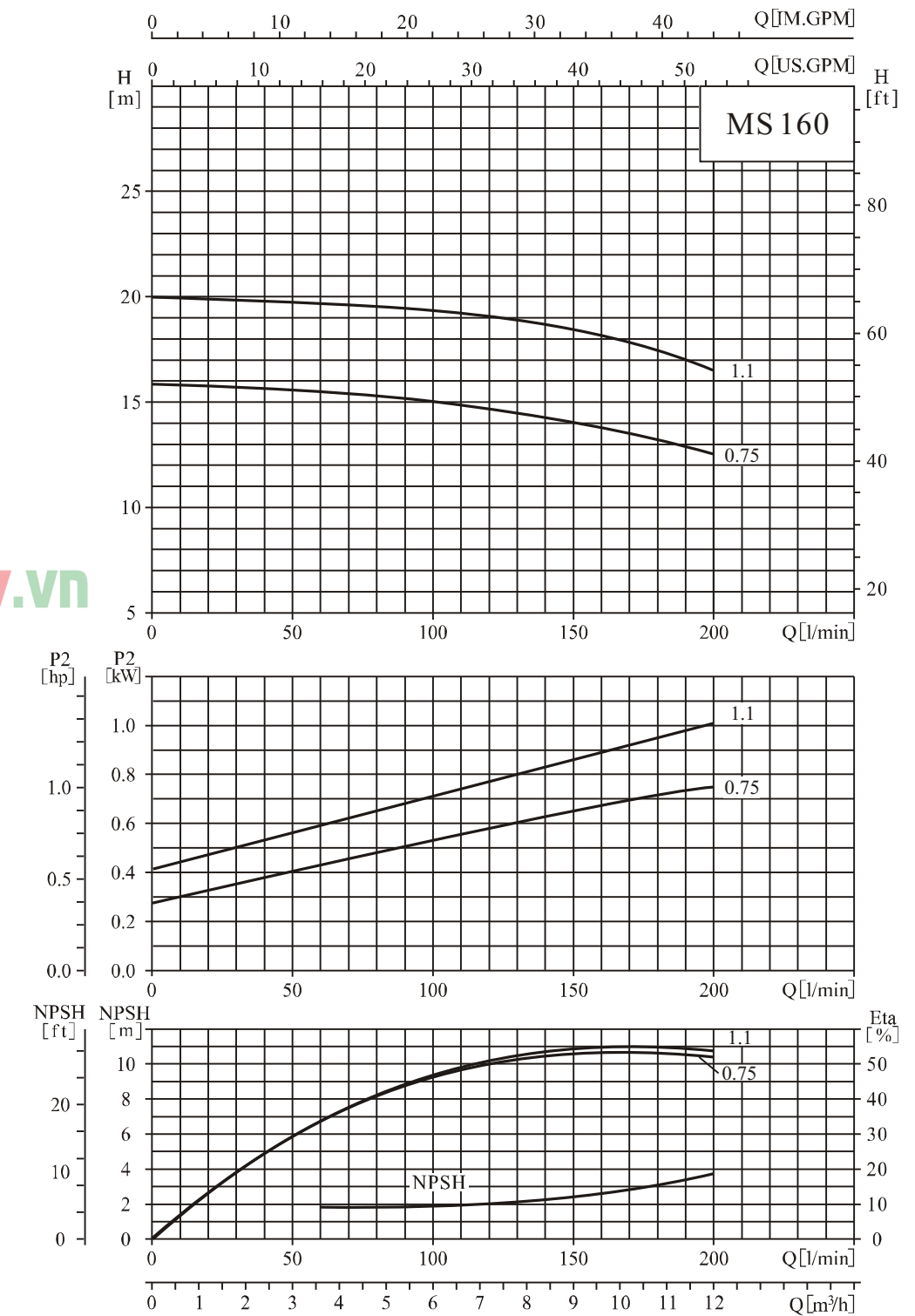
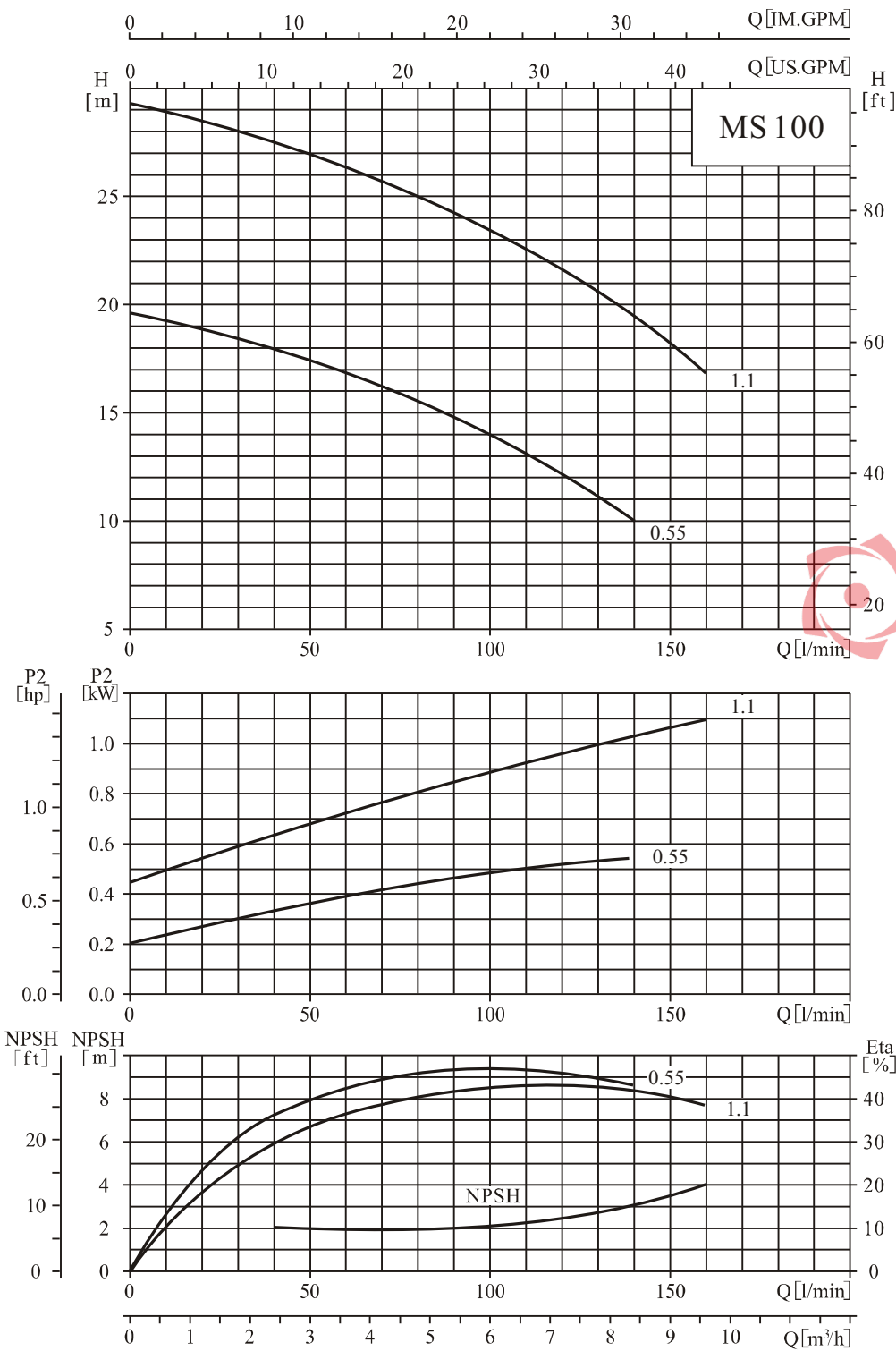

MS250,50Hz

MS330,50Hz

● Performance curve

ISO9906 Annex A

● Performance curve

ISO9906 Annex A

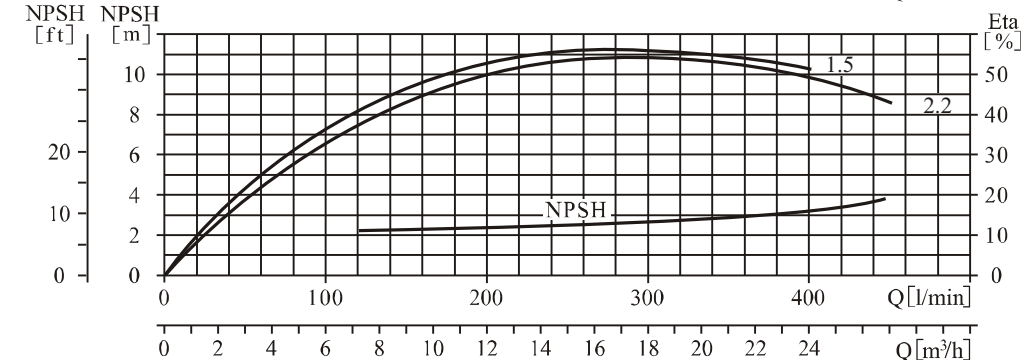
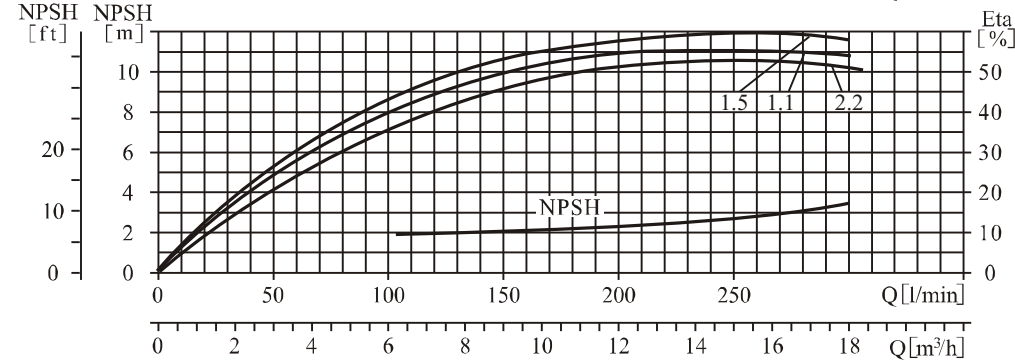
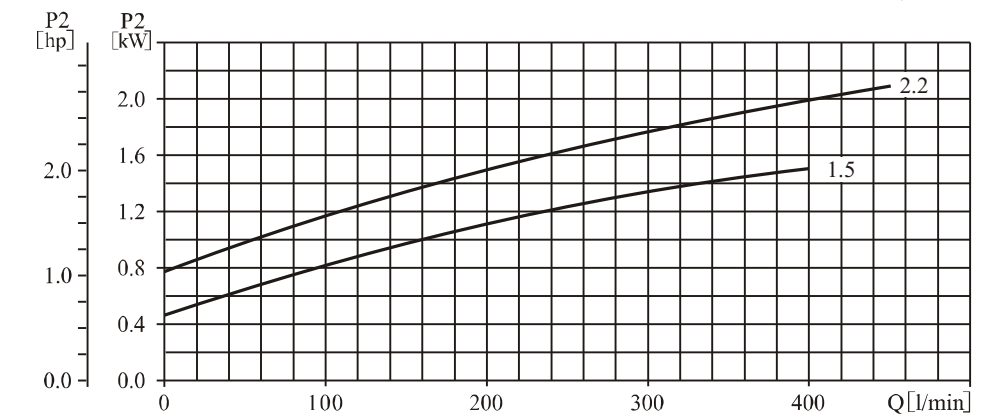
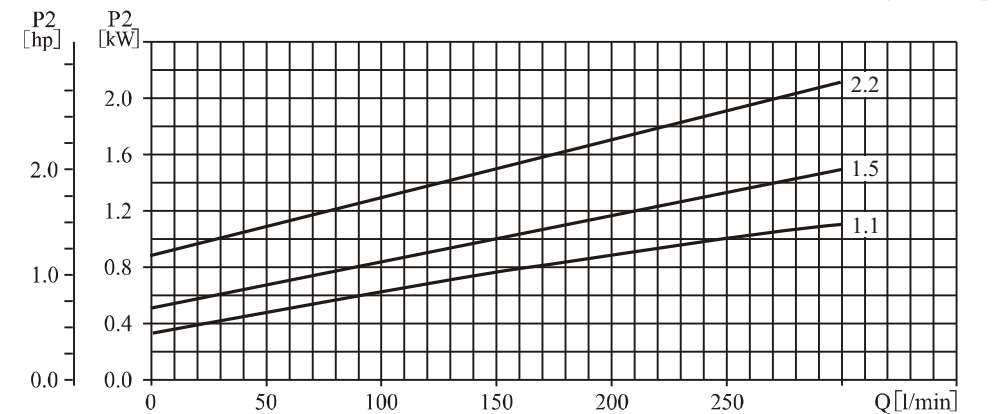
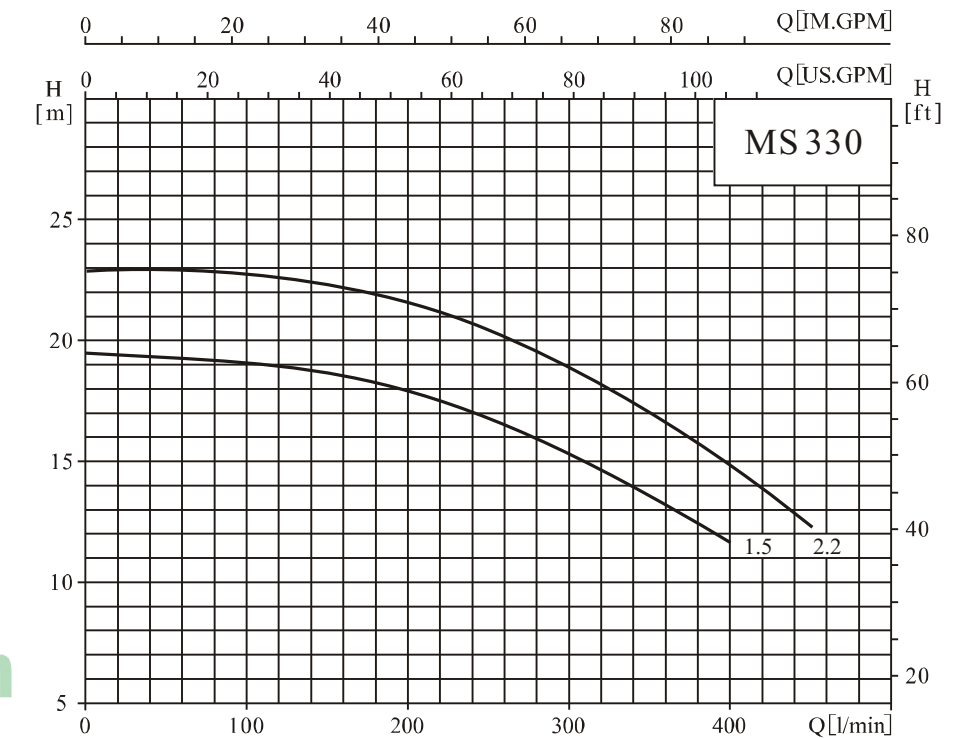
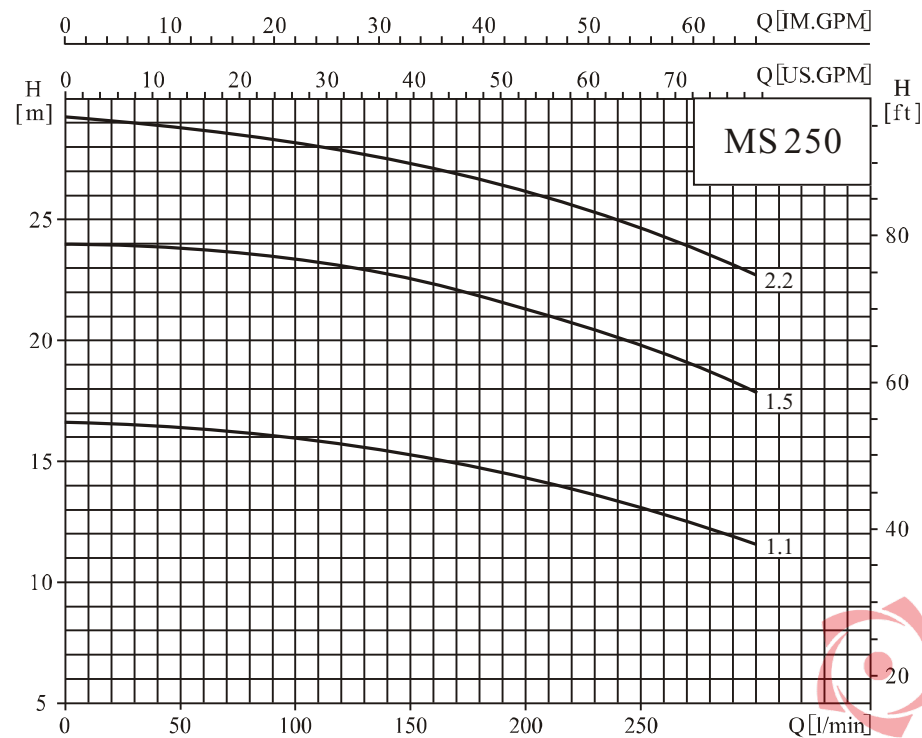

MSS100,60Hz

MSS160,60Hz

● Performance curve

ISO9906 Annex A

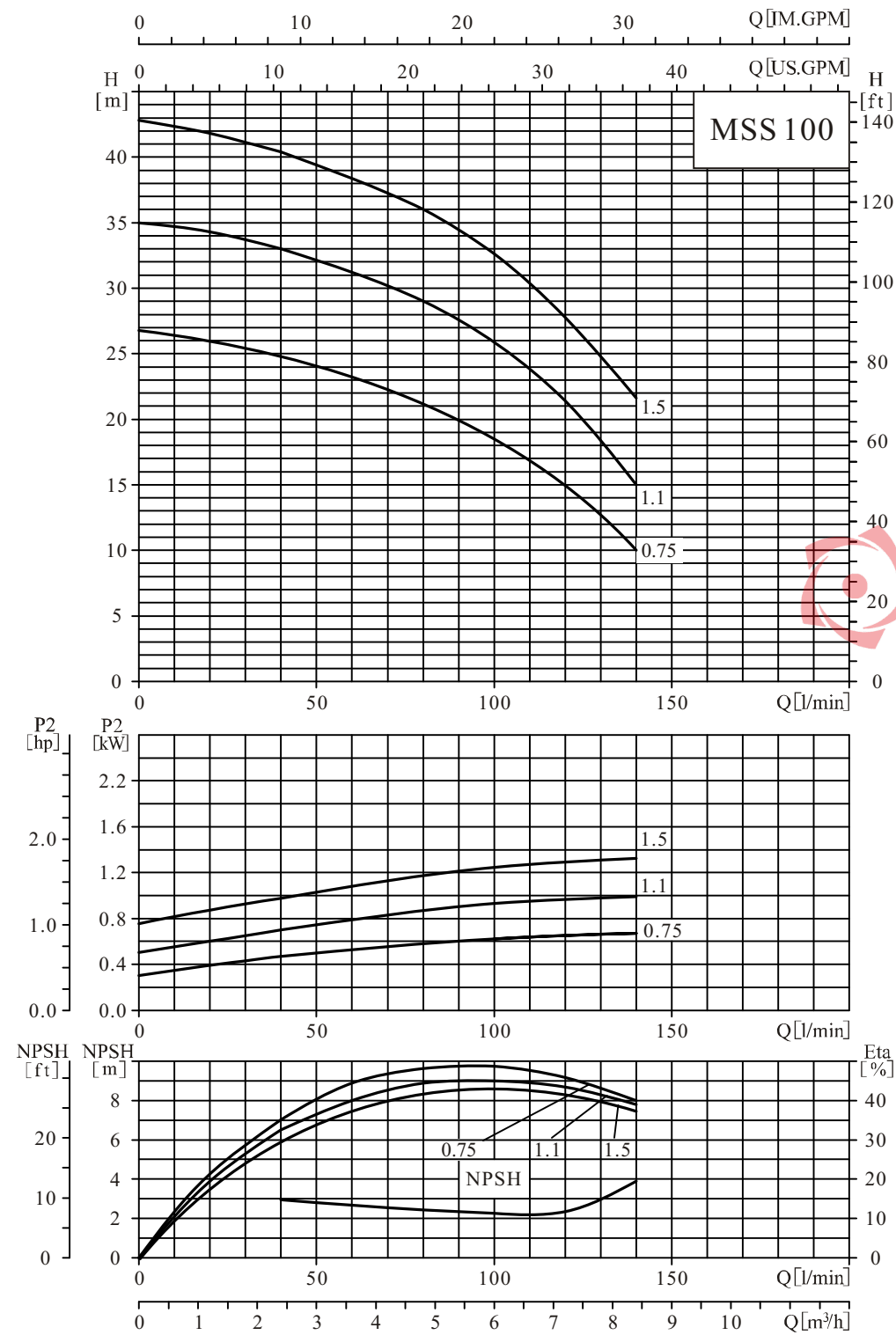

● Performance curve

ISO9906 Annex A

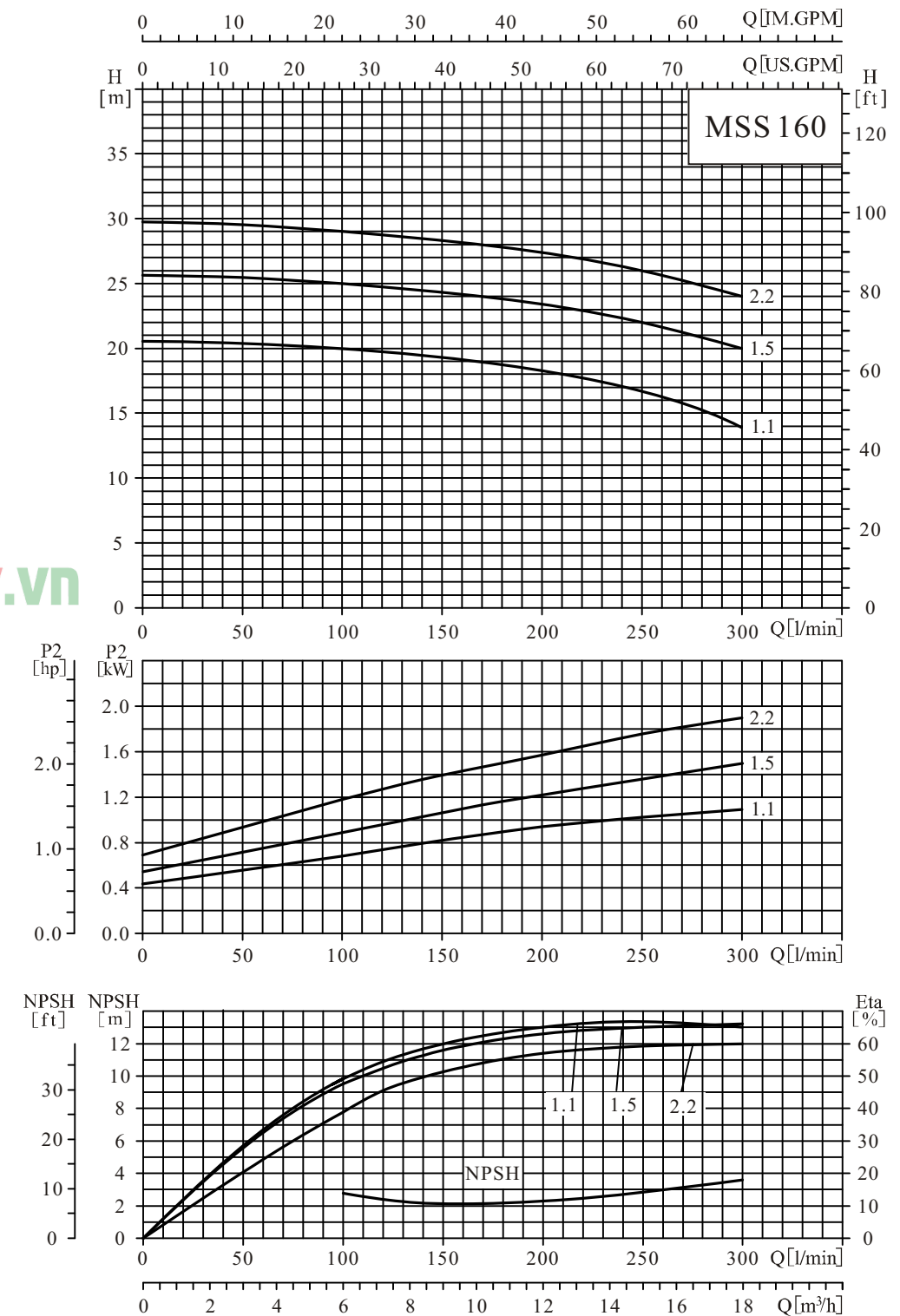

MSS250,60Hz

MSS330,60Hz

● Performance curve

ISO9906 Annex A

● Performance curve

ISO9906 Annex A

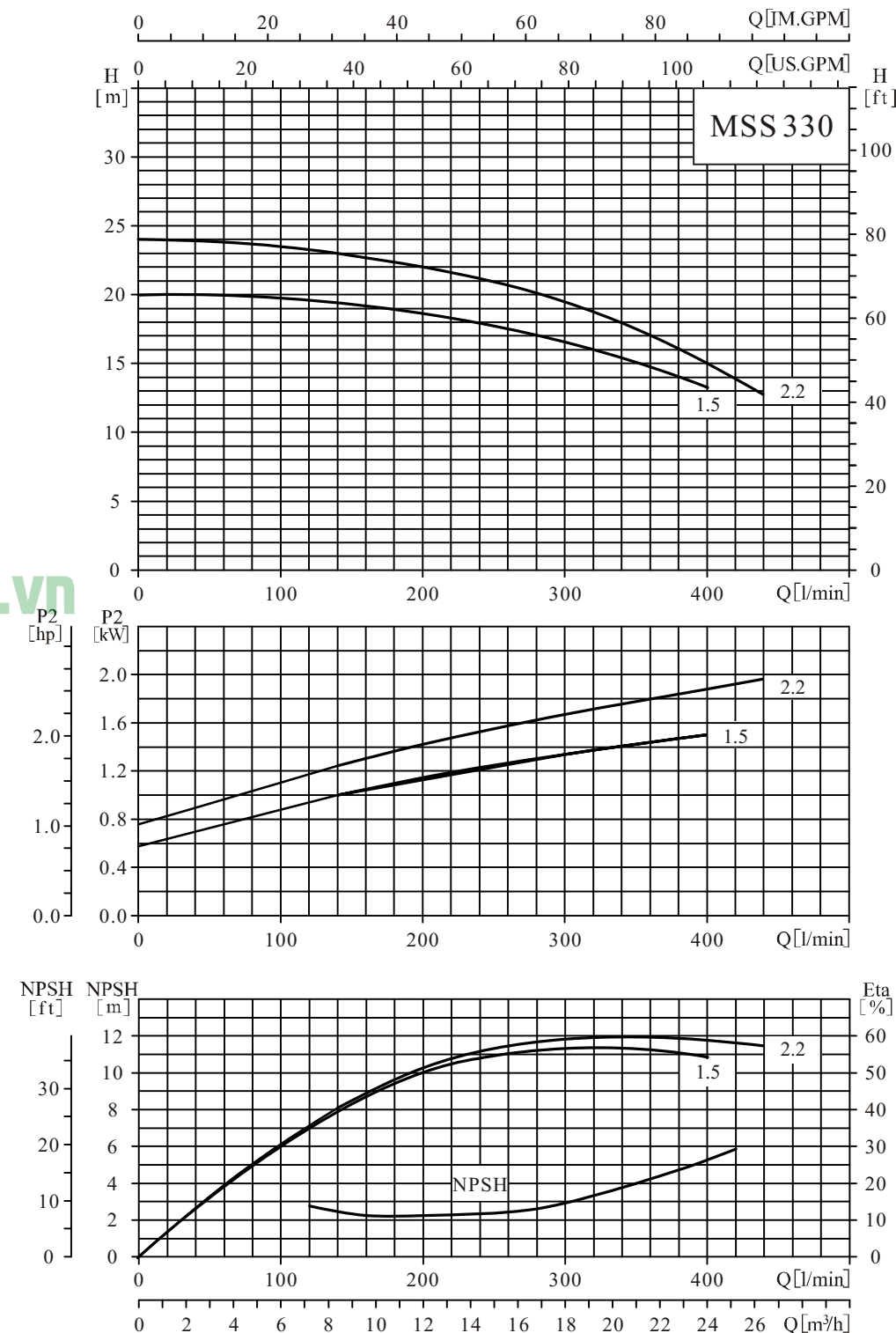
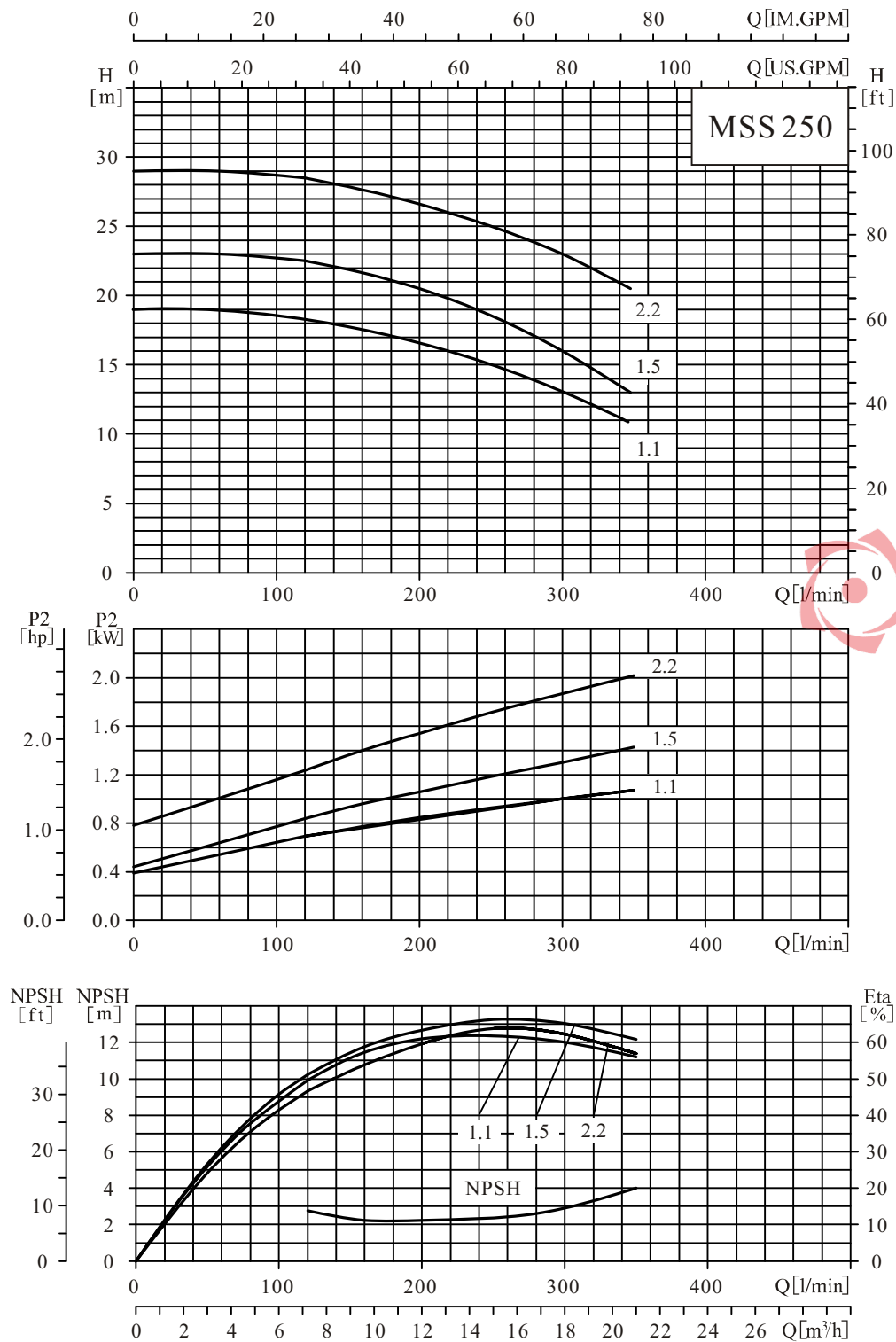

● Installation sketch

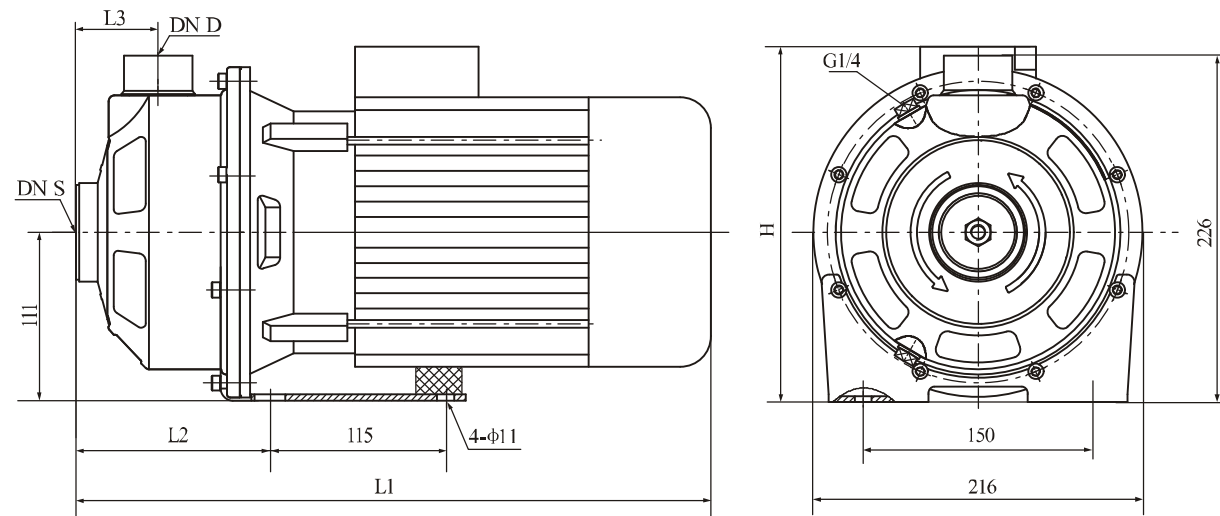

● Size and weight-60Hz

Model	Motor		L1	L2	L3	H	DN S	DN D	Weight
	Phase	Power kW							
MSS100/0.75	3PH/1PH	0.75	361	113	51	223 / 245	G1 $\frac{1}{4}$	G1	14
MSS100/1.1		1.1	361	113	51	223 / 245	G1 $\frac{1}{4}$	G1	14
MSS100/1.5		1.5	401	113	51	232 / 253	G1 $\frac{1}{4}$	G1	20
MSS160/1.1		1.1	375	127	54	223 / 245	G1 $\frac{1}{2}$	G1 $\frac{1}{4}$	16
MSS160/1.5		1.5	415	127	54	232 / 253	G1 $\frac{1}{2}$	G1 $\frac{1}{4}$	20
MSS160/2.2		2.2	415	127	54	232 / 253	G1 $\frac{1}{2}$	G1 $\frac{1}{4}$	23
MSS250/1.1		1.1	375	127	54	223 / 245	G1 $\frac{1}{2}$	G1 $\frac{1}{4}$	16
MSS250/1.5		1.5	415	127	54	232 / 253	G1 $\frac{1}{2}$	G1 $\frac{1}{4}$	20
MSS250/2.2		2.2	415	127	54	232 / 253	G1 $\frac{1}{2}$	G1 $\frac{1}{4}$	23
MSS330/1.5		1.5	415	127	54	232 / 253	G2	G1 $\frac{1}{4}$	20
MSS330/2.2		2.2	415	127	54	232 / 253	G2	G1 $\frac{1}{4}$	23

● Size and weight-50Hz

Model	Motor		L1	L2	L3	H	DN S	DN D	Weight
	Phase	Power kW							
MS60/0.37	3PH/1PH	0.37	328	113	51	216 / 230	G1 $\frac{1}{4}$	G1	10
MS60/0.55		0.55	328	113	51	216 / 230	G1 $\frac{1}{4}$	G1	12
MS60/0.75		0.75	361	113	51	223 / 245	G1 $\frac{1}{4}$	G1	14
MS100/0.55		0.55	328	113	51	216 / 230	G1 $\frac{1}{4}$	G1	12
MS100/1.1		1.1	361	113	51	223 / 245	G1 $\frac{1}{4}$	G1	16
MS160/0.75		0.75	375	127	54	223 / 245	G1 $\frac{1}{2}$	G1 $\frac{1}{4}$	14
MS160/1.1		1.1	375	127	54	223 / 245	G1 $\frac{1}{2}$	G1 $\frac{1}{4}$	16
MS250/1.1		1.1	375	127	54	223 / 245	G1 $\frac{1}{2}$	G1 $\frac{1}{4}$	16
MS250/1.5		1.5	415	127	54	232 / 253	G1 $\frac{1}{2}$	G1 $\frac{1}{4}$	20
MS250/2.2		2.2	415	127	54	232 / 253	G1 $\frac{1}{2}$	G1 $\frac{1}{4}$	23
MS330/1.5		1.5	415	127	54	232 / 253	G2	G1 $\frac{1}{4}$	20
MS330/2.2		2.2	415	127	54	232 / 253	G2	G1 $\frac{1}{4}$	23

