

Pompe centrifughe monoblocco ad asse orizzontale costruite secondo le norme EN 733; trovano vasto utilizzo nell'alimentazione idrica, negli impianti di pressurizzazione e antincendio, raffreddamento, riscaldamento, irrigazione, applicazioni agricole e industriali; come standard vengono fornite di controflangia.

Monobloc horizontal centrifugal pumps, constructed to EN 733 standards; widely used in water supplies, pressurisation and fire-fighting systems, cooling, heating, irrigation, industrial and agricultural applications; standard supply with counter-flange.

Bombas centrifugas monobloque de eje horizontal fabricadas según las normas EN 733; se utilizan en gran parte en la alimentación hídrica, en las instalaciones de presurización y antiincendio, enfriamiento, calefacción, riego, aplicaciones agrícolas e industriales; según el estándar se suministran con contrabrida.

Pompes centrifuges monobloc à axe horizontal, fabriquées conformément aux normes EN 733. Elles trouvent une ample utilisation dans l'approvisionnement d'eau, dans les installations de pressurisation et anti-incendie, refroidissement, chauffage, irrigation, applications agricoles et industrielles; fournies de série avec contre-bride.

CARATTERISTICHE COSTRUTTIVE / CONSTRUCTION FEATURES CARACTERÍSTICAS CONSTRUCTIVAS / CARACTÉRISTIQUES D'EXÉCUTION

Corpo pompa	ghisa
Pump body	cast iron
Cuerpo bomba	fundición
Corps de pompe	fonte
Supporto motore	ghisa
Motor bracket	cast iron
Soporte motor	fundición
Support moteur	fonte
Girante	ghisa, bronzo o acciaio
Impeller	cast iron, bronze or stainless steel
Rodete	fundición, bronce o acero
Turbine	fonte, bronze ou acier
Tenuta meccanica	ceramica-grafite
Mechanical seal	ceramic-graphite
Sello mecánico	cerámica-grafito
Garniture mécanique	céramique-graphite
Sporgenza albero motore	acciaio AISI 304
Pump shaft end	stainless steel AISI 304
Bomba eje	acero AISI 304
Pompe arbre	acier AISI 304
Temperatura del liquido	
Liquid temperature	-10 ÷ +90 °C
Temperatura del líquido	
Température du liquide	
Pressione di esercizio	
Operating pressure	max 10 bar
Presión de trabajo	
Pression de fonctionnement	
MOTORE / MOTOR / MOTOR / MOTEUR	
Motore 2 poli a induzione	3~ 230/400V-50Hz P ≤ 4kW
2 pole induction motor	3~ 400/690V-50Hz P > 4kW
Motor de 2 polos a inducción	
Moteur à induction à 2 pôles	1~ 230V-50Hz
Classe di isolamento	
Insulation class	F
Clase de aislamiento	
Classe d'isolation	
Grado di protezione	
Protection degree	IP55
Grado de protección	
Protection	

TYPE	P ₂ nom. HP kW		3~ P ₁ max kW A 3x400V 50 Hz		Q (m ³ /h - l/min)																				
					0	30	33	36	39	42	45	48	54	60	66	72	78	84	96	108	120	132	138	144	150
					0	500	550	600	650	700	750	800	900	1000	1100	1200	1300	1400	1600	1800	2000	2200	2300	2400	2500
H (m)																									
65-125B1	7,5	5,5	6,4	11,3	19,7	20,6	20,5	20,4	20,4	20,3	20,2	20,2	20,0	19,7	19,3	18,8	18,2	17,5	16,3	15,0					
65-125B	7,5	5,5	6,6	11,0	19,7	20,6	20,5	20,4	20,4	20,3	20,2	20,2	20,0	19,7	19,3	18,8	18,2	17,5	16,3	15,0	13,1				
65-125A1	10	7,5	8,6	15,1	24,6	25,2	25,2	25,1	25,1	25,0	24,8	24,9	24,7	24,5	24,2	23,9	23,5	23,0	22,0	20,6	18,8				
65-125A	10	7,5	8,8	14,4	24,6	25,2	25,2	25,1	25,1	25,0	24,9	24,9	24,7	24,5	24,2	23,9	23,5	23,0	22,0	20,6	18,8	16,8			
65-160C	12,5	9,2	10,1	16,8	28,9					30,6	30,5	30,3	30,0	29,6	29,1	28,5	27,9	27,2	25,3	22,9	20,2	17,5	16,0	13,9	
65-160B	15	11,0	12,7	20,6	33,2					35,1	35,0	34,9	34,6	34,3	33,8	33,3	32,8	32,1	30,4	28,2	25,5	22,5	21,4	20,4	
65-160A	20	15,0	17,1	28,5	40,1					42,5	42,5	42,5	42,3	42,1	41,8	41,4	41,0	40,4	38,9	37,1	35,3	32,8	31,7	30,9	
65-200C	20	15	17,0	28,3	44,4								46,1	45,4	44,7	44,0	43,2	42,4	40,3	37,5	33,7	28,9	26,8		
65-200B	25	18,5	21,2	34,8	51,7								53,9	53,4	52,7	52,0	51,3	50,4	48,6	45,9	43,0	39,4	37,1	34,6	
65-200A	30	22,5	25,4	41,7	60,3								61,8	61,4	61,0	60,4	59,8	59,1	57,1	54,6	51,6	48,3	46,5	44,4	
65-250B	40	30	30,8	55,3	80,6								80,6	79,5	78,4	77,1	75,7	74,1	70,4	66,1	61,0	54,7	51,0	47,3	
65-250A	50	37	37,0	69,2	91,6								91,6	90,8	89,8	88,6	87,4	85,9	82,5	77,8	72,8	67,4	64,3	60,8	57,9

TYPE	P ₂ nom. HP kW		3~ P ₁ max kW A 3x400V 50 Hz		Q (m ³ /h - l/min)																				
					0	66	72	78	84	96	108	120	132	138	144	156	168	180	195	210	225	240			
					0	1100	1200	1300	1400	1600	1800	2000	2200	2300	2400	2600	2800	3000	3250	3500	3750	4000			
H (m)																									
80-160E	12,5	9,2	9,8	16,3	21,5	22,9	22,5	22,1	21,6	20,8	19,9	18,9	17,7	17,2	16,6	15,3	13,7								
80-160D	15	11	12,2	20,0	25,4	27,3	27,0	26,6	26,3	25,4	24,5	23,5	22,4	21,8	21,2	19,9	18,3	16,4							
80-160C	20	15	14,5	24,5	29,0	30,9	30,7	30,4	30,1	29,4	28,5	27,4	26,3	25,8	25,3	24,1	22,5	20,7	18,4						
80-160B	25	18,5	18,1	30,3	33,6	35,9	35,7	35,4	35,2	34,5	33,7	32,9	32,0	31,6	31,1	30,0	28,6	27,0	24,5	22,0					
80-160A	30	22,5	22,0	37,0	38,0	40,5	40,4	40,2	40,1	39,6	39,1	38,4	37,5	37,1	36,6	35,4	34,1	32,6	30,4	28,3	23,9				
80-200B	40	30	32,0	57,2	50,4				54,5	53,9	53,2	52,3	51,3	50,7	50,2	48,9	47,4	45,8	43,4	40,9	38,5				
80-200A	50	37	38,6	71,6	57,3				61,7	61,3	60,6	59,4	58,2	57,8	57,5	56,8	55,4	53,7	51,5	49,1	46,6	43,9			

TYPE	P ₂ nom. HP kW		3~ P ₁ max kW A 3x400V 50 Hz		Q (m ³ /h - l/min)																					
					0	96	108	120	132	138	144	156	168	180	195	210	225	240	270	300	330					
					0	1600	1800	2000	2200	2300	2400	2600	2800	3000	3250	3500	3750	4000	4500	5000	5500					
H (m)																										
100-160B	40	30	31,9	57,1	41,7	40,7	40,8	40,7	40,4	40,3	40,1	39,6	39,1	38,5	37,8	37,0	36,1	35,0	32,3	29,2	25,7					
100-160A	50	37	37,5	70,2	46,0	45,1	45,2	45,1	44,9	44,8	44,7	44,3	43,9	43,3	42,7	42,0	41,1	40,2	37,9	35,0	31,9					

CM EN 733 ~ 2900 r.p.m.

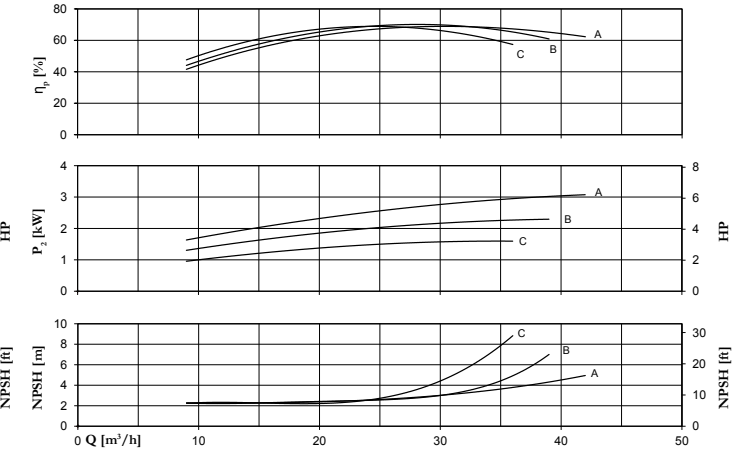
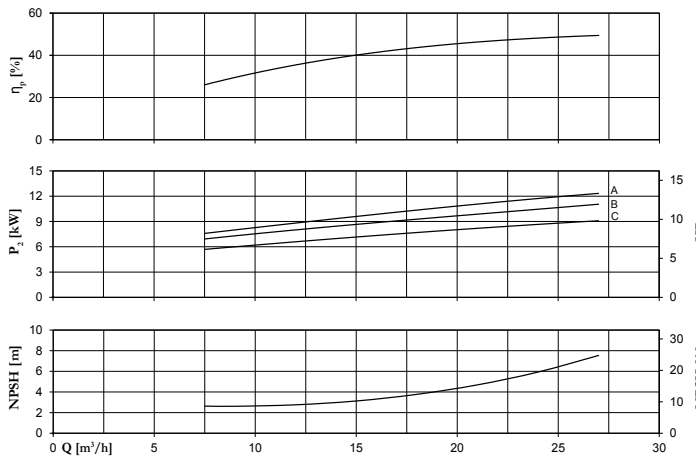
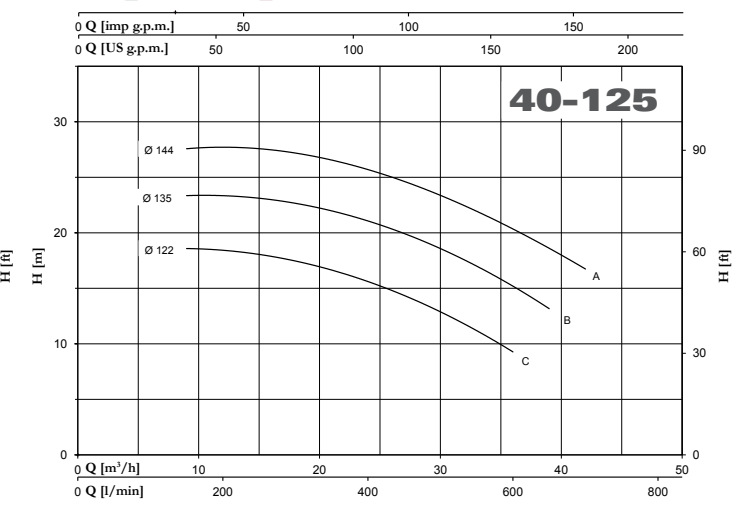
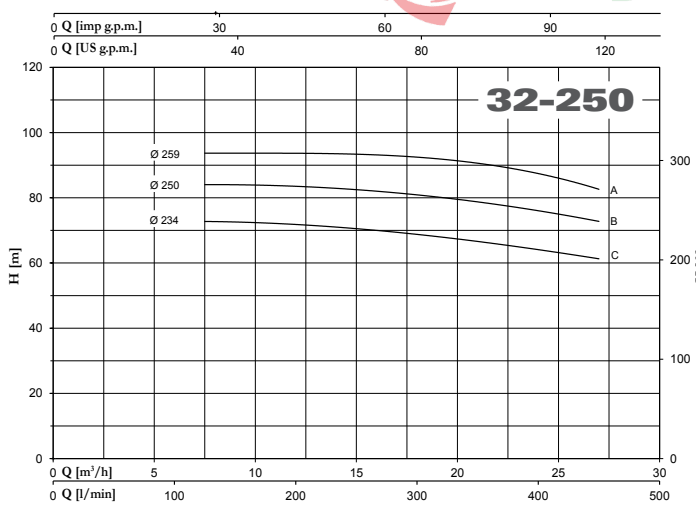
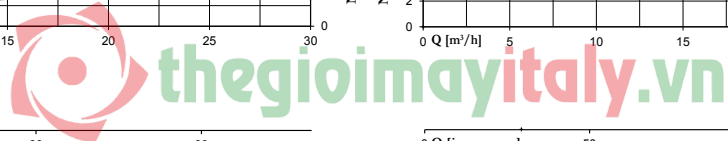
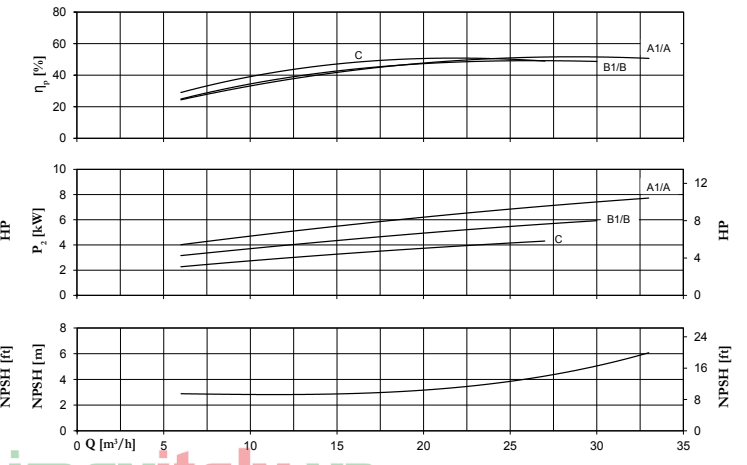
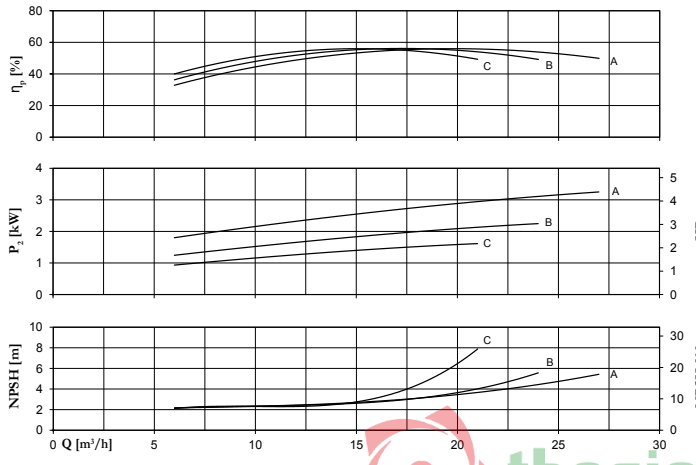
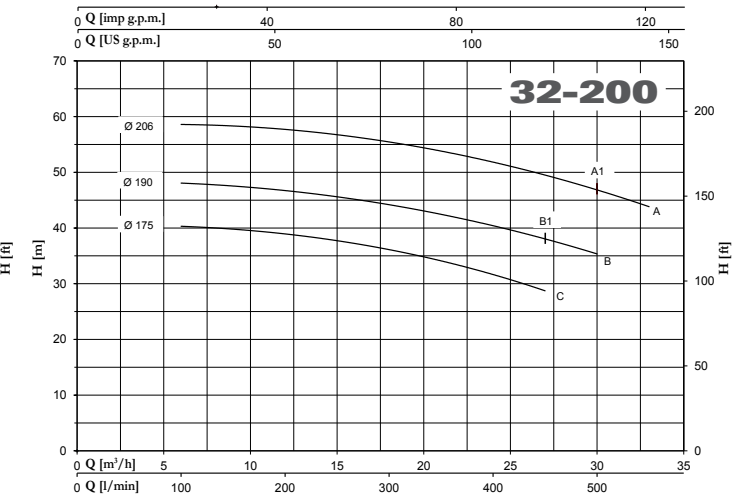
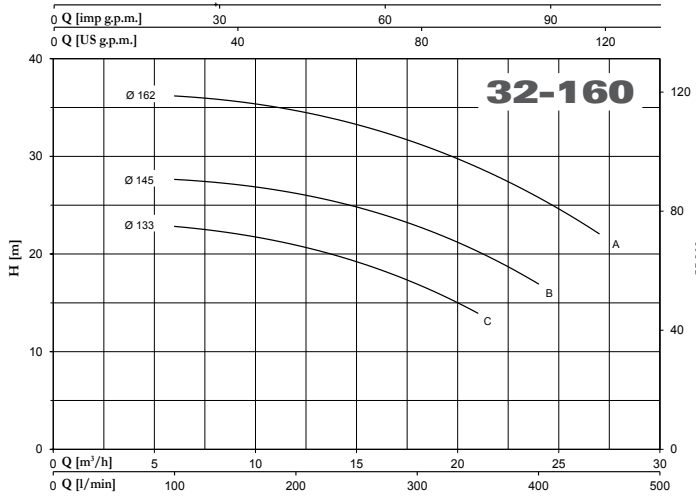

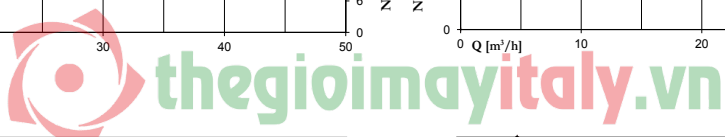
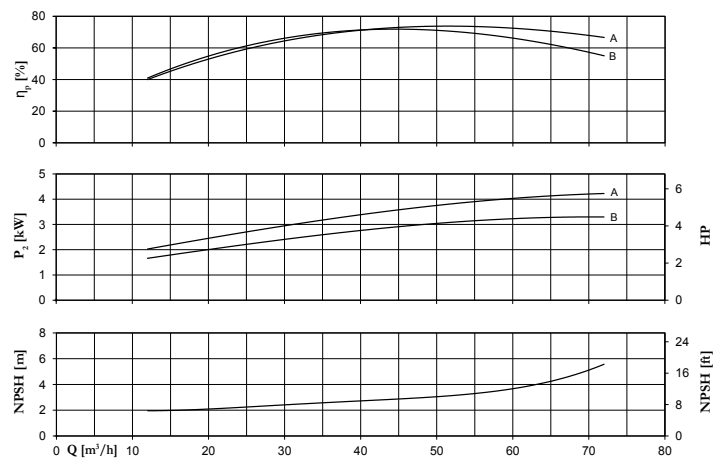
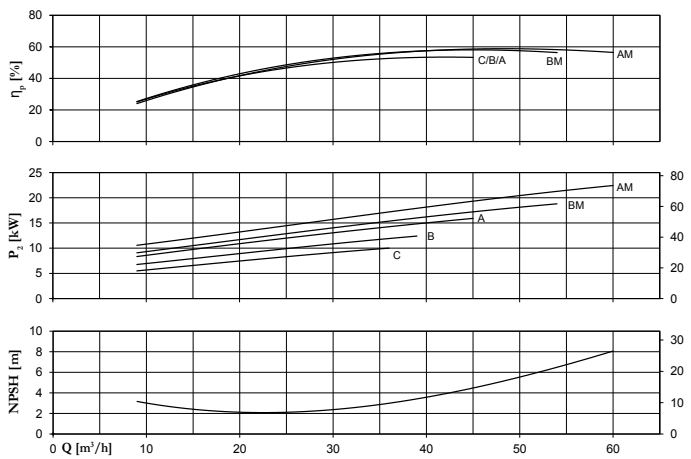
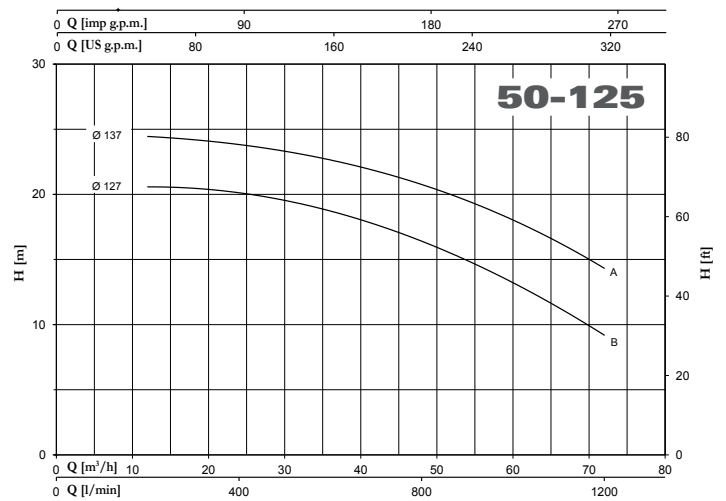
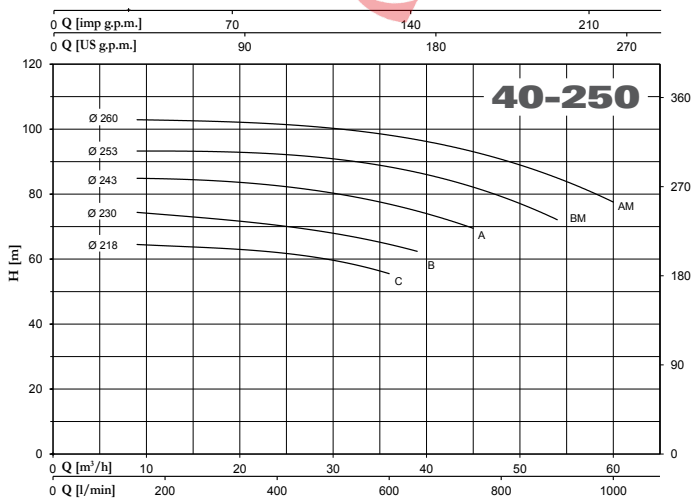
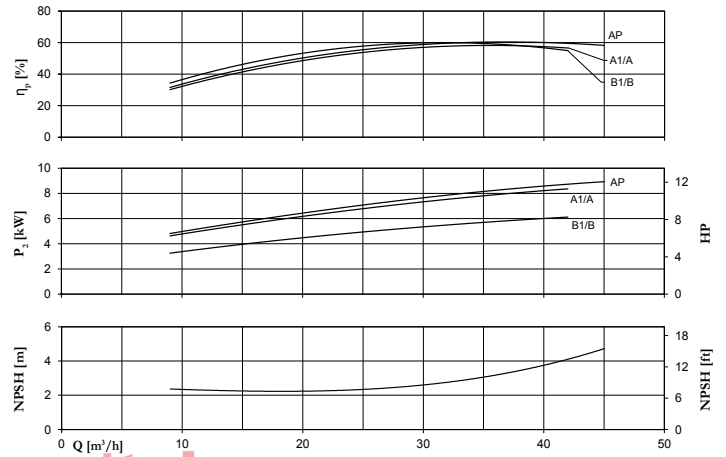
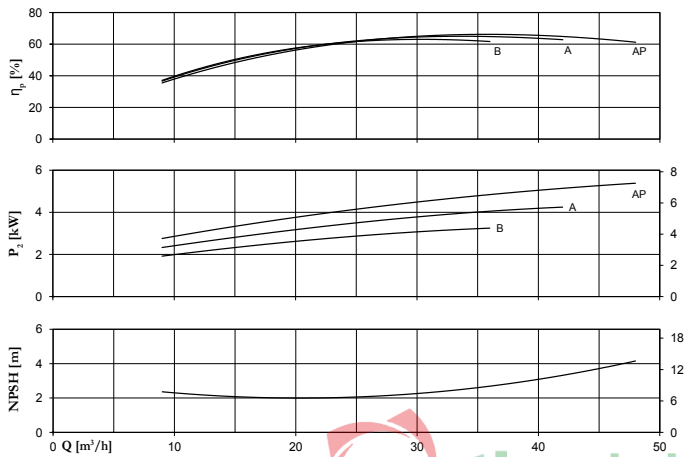
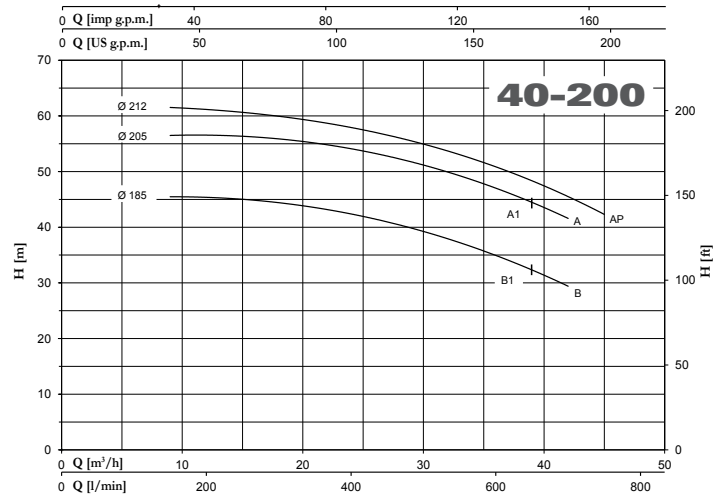
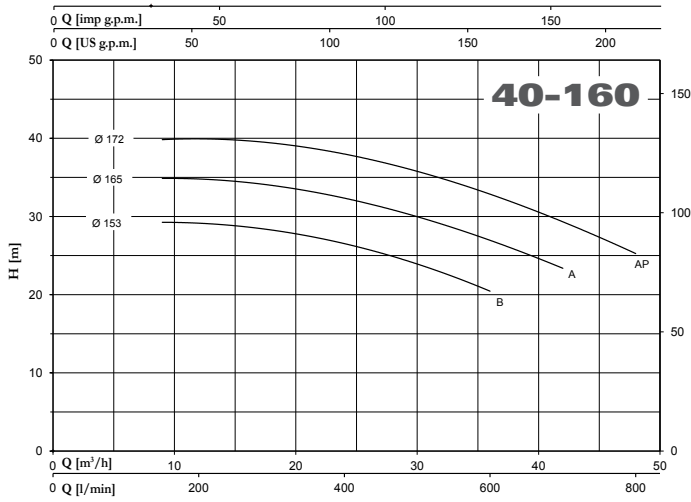

CM EN 733 ~ 2900 r.p.m.

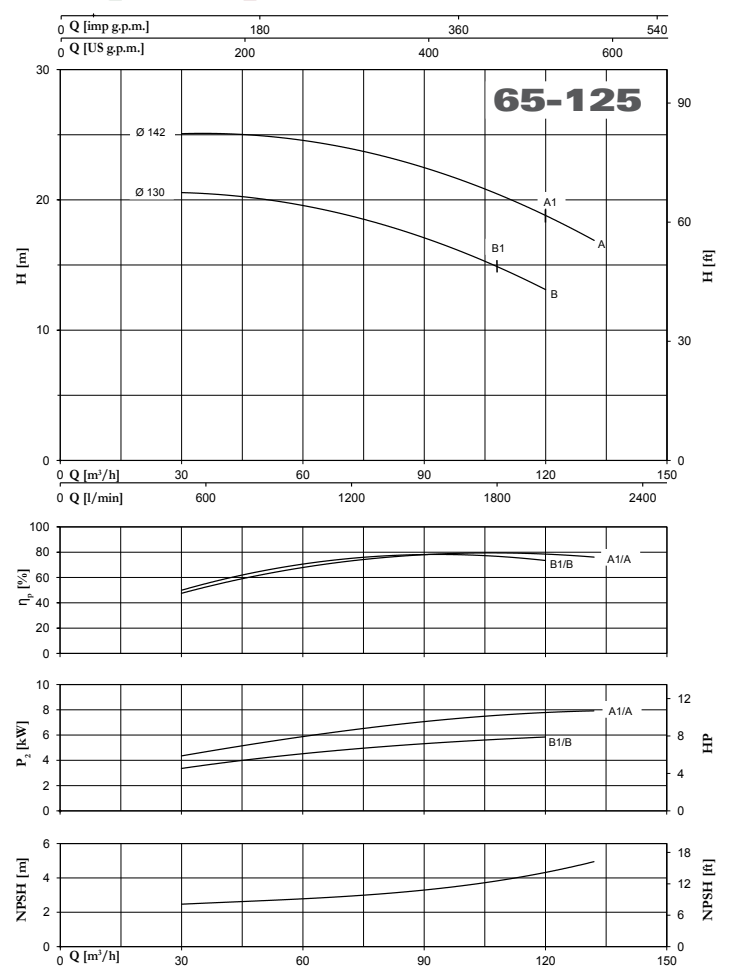
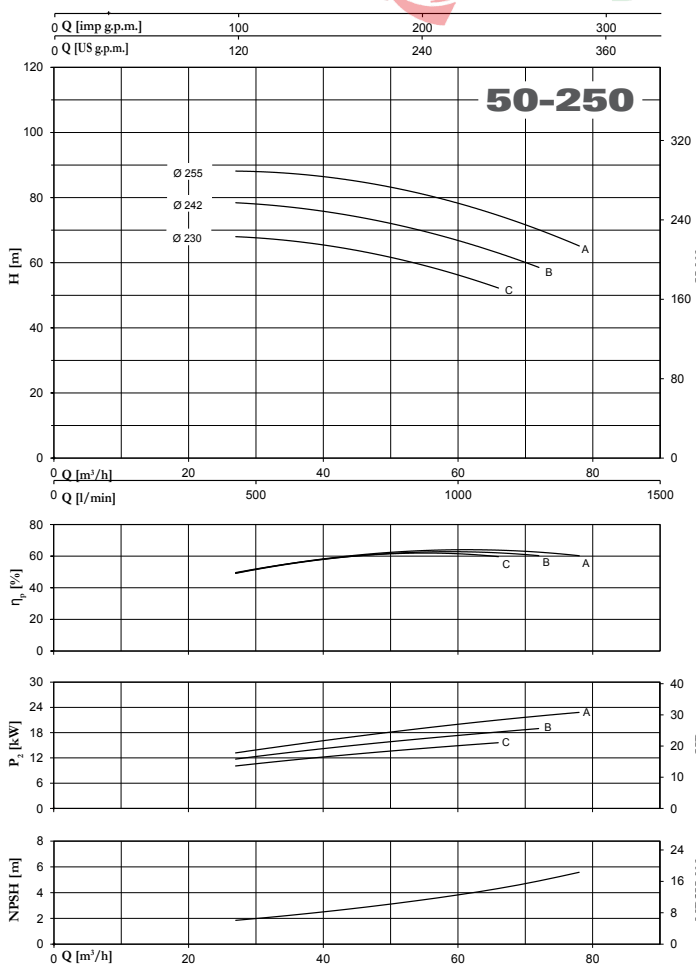
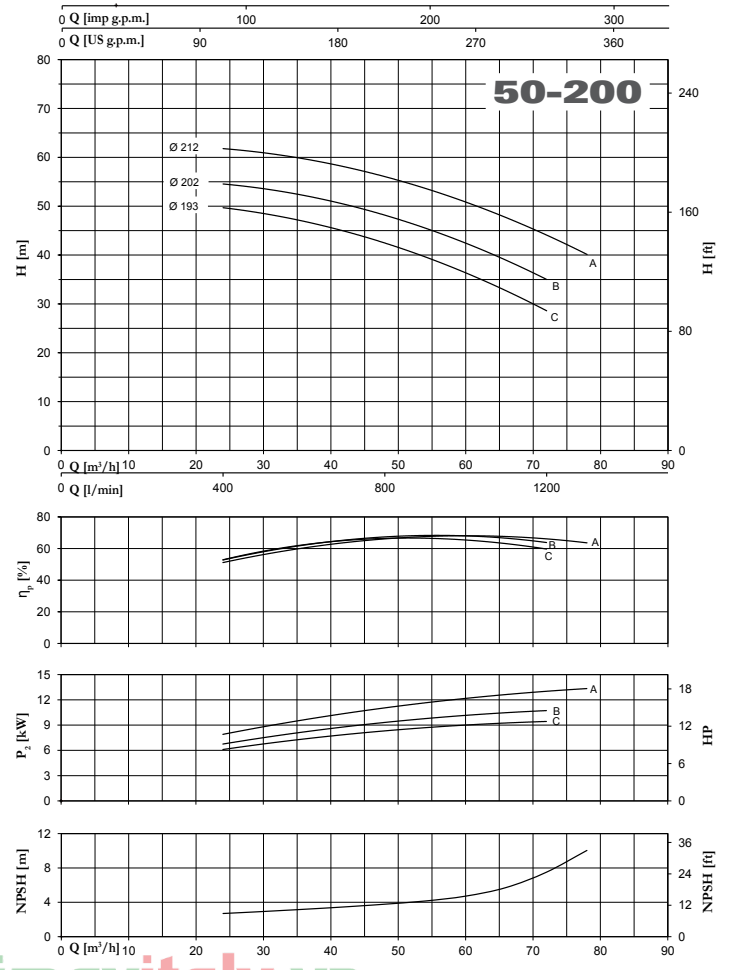
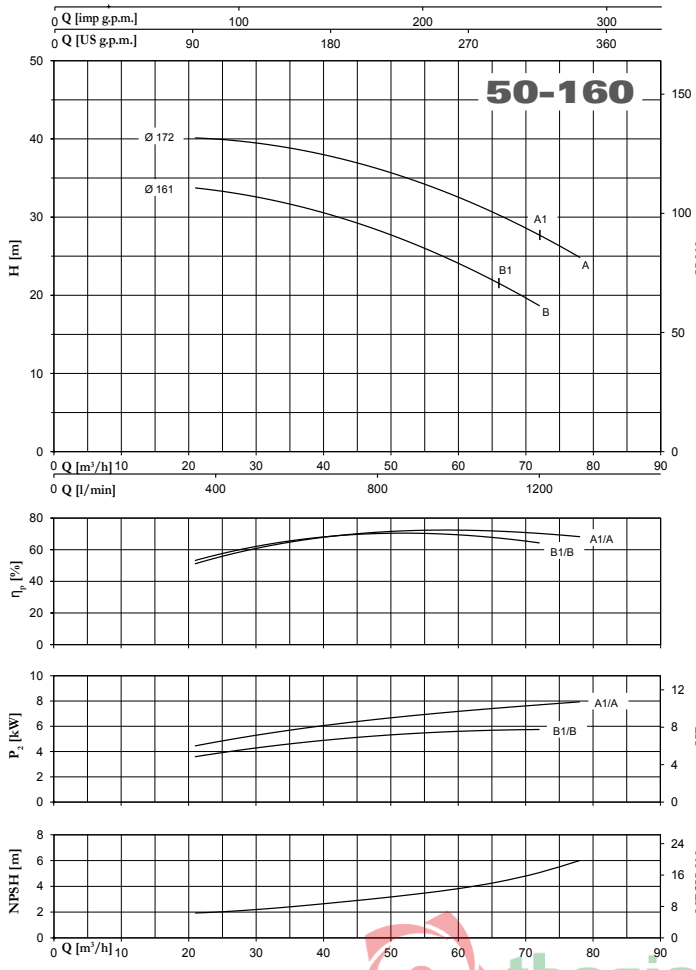

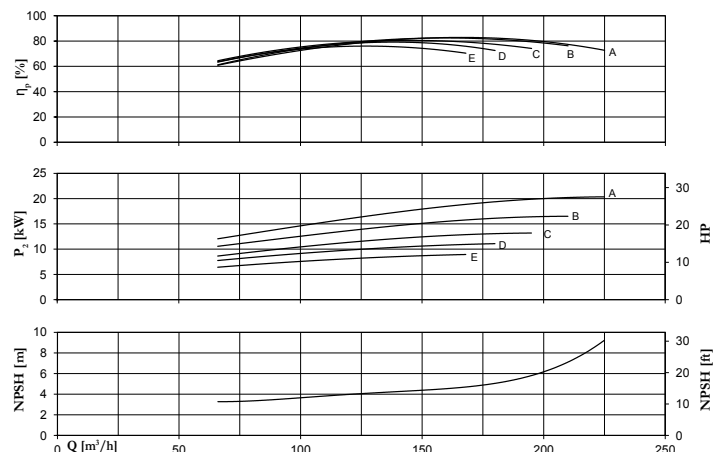
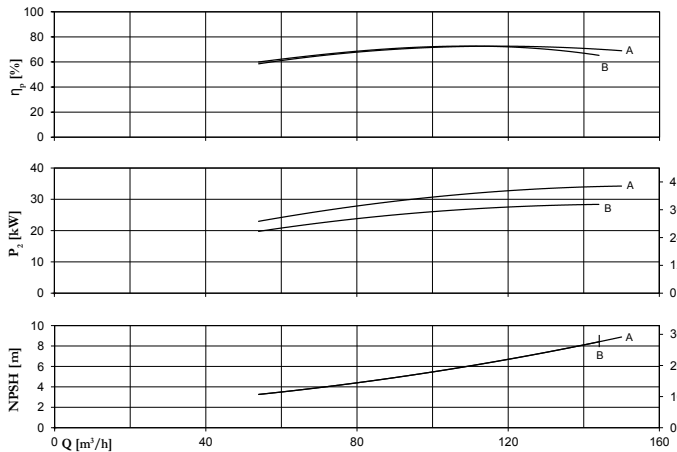
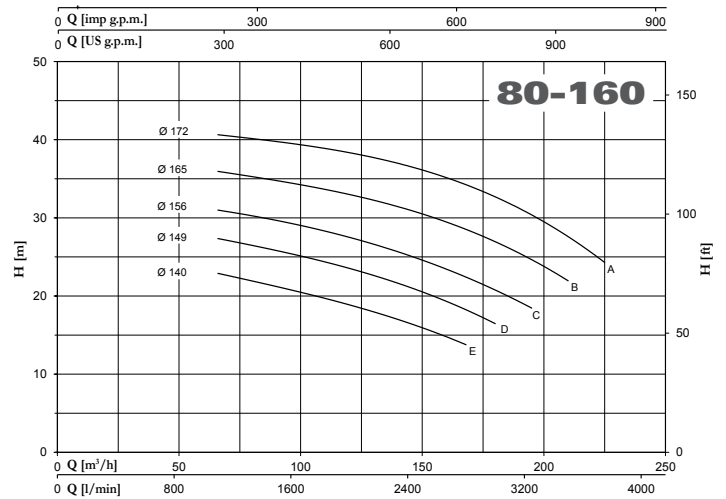
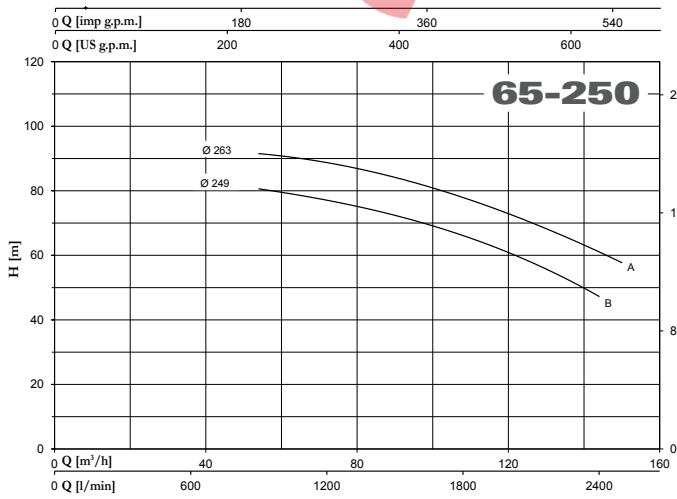
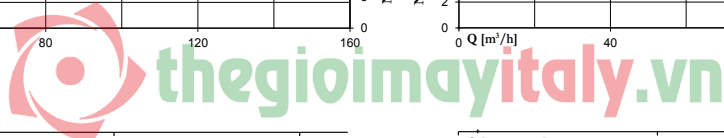
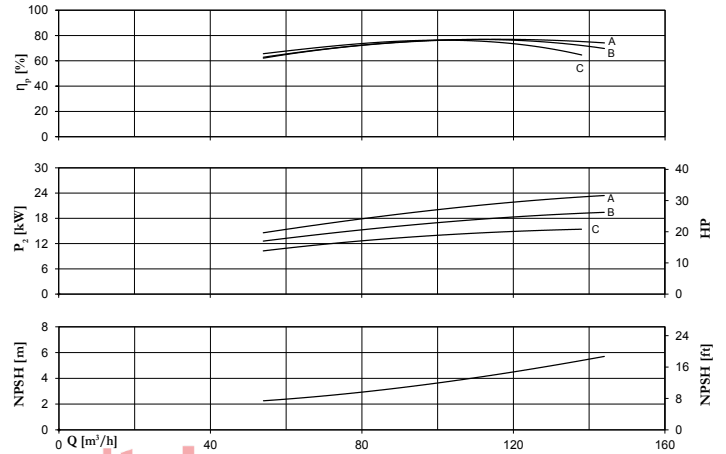
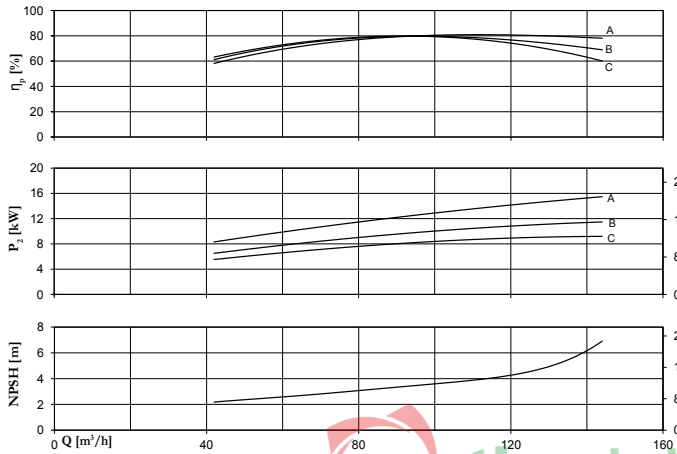
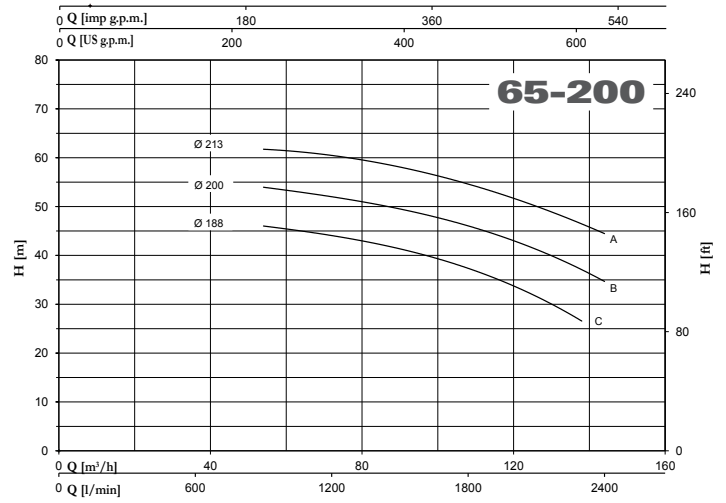
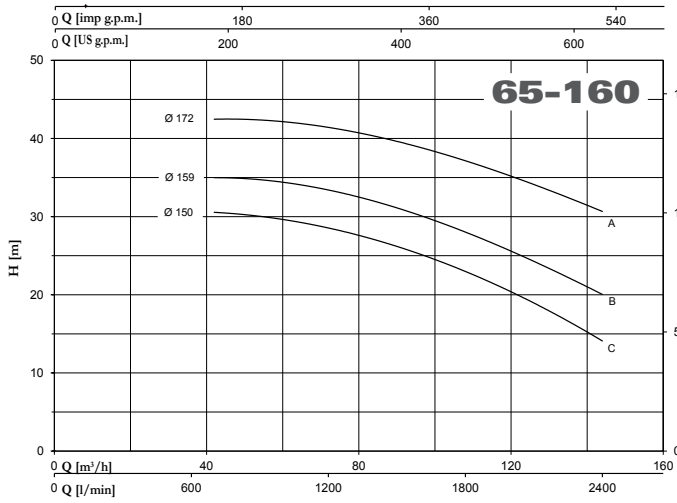

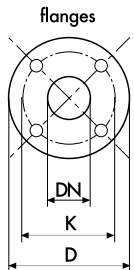
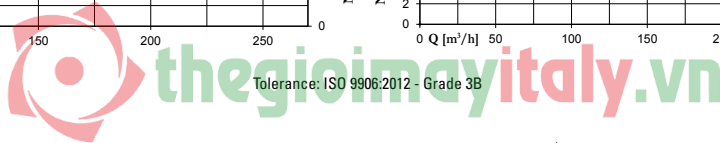
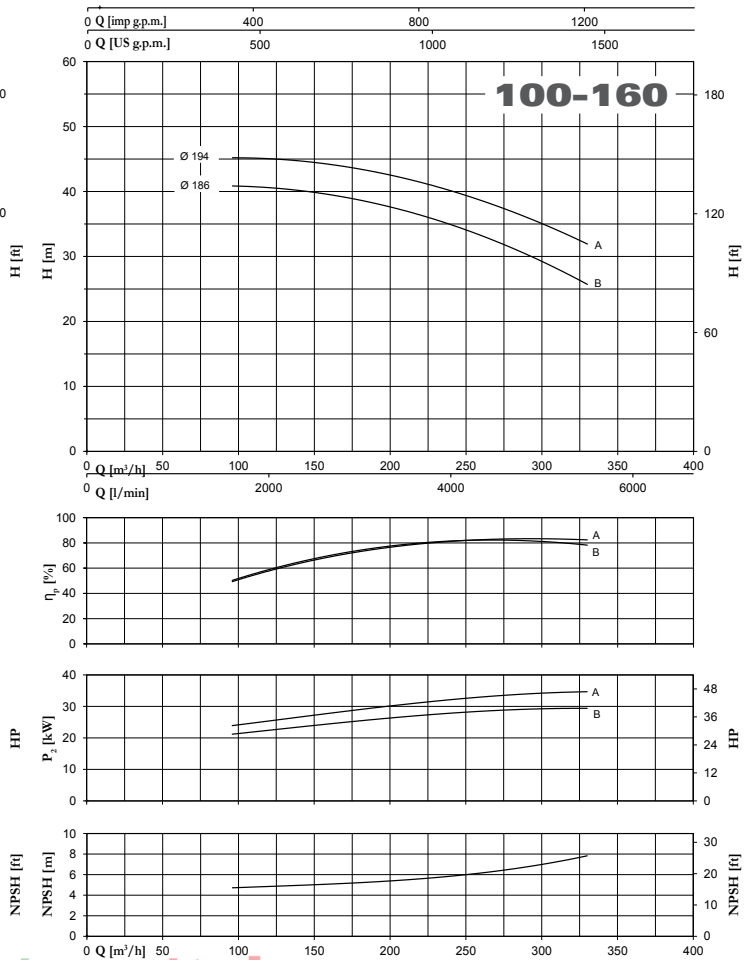
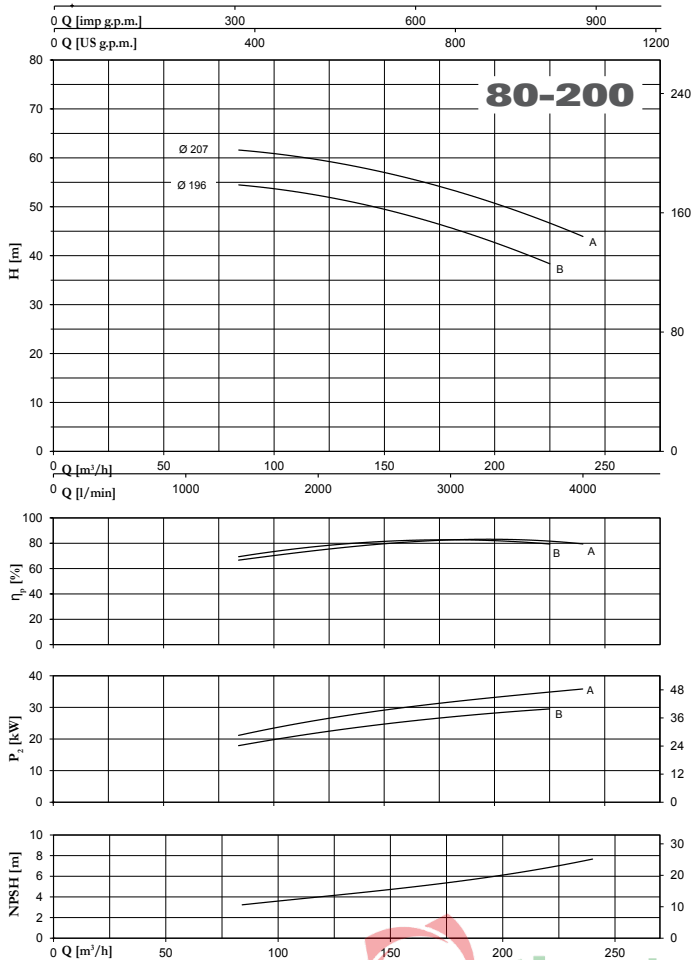

CM EN 733 ~ 2900 r.p.m.

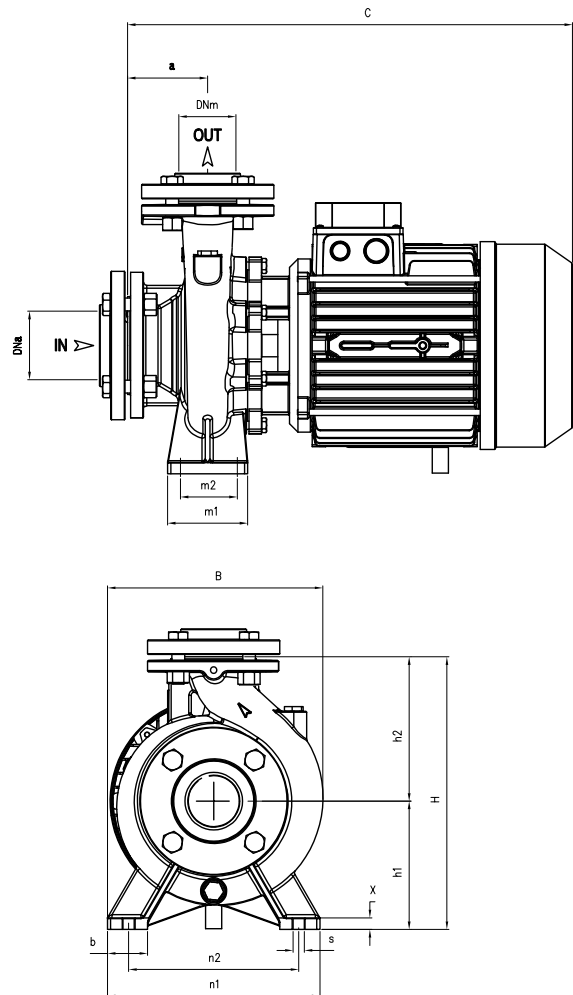

DIMENSIONS (mm)				
DN	D	K	holes	
			n°	Ø
32	140	100	4	18
40	150	110	4	18
50	165	125	4	18
65	185	145	4	18
80	200	160	8	18
100	220	180	8	18
125	250	210	8	18

TYPE	TRUCK		CONTAINER	
	PALLET (cm)	N° pumps	PALLET (cm)	N° pumps
32-160	80X120X155	24	80X120X190	30
32-200 C	80X120X155	24	80X120X180	24
32-200 A/B	100X120X140	18	100X120X185	24
32-250 A	85X110X120	6	85X110X170	9
32-250 B/C	80X120X120	6	80X120X170	9
40-125	80X120X155	24	80X120X190	30
40-160	80X120X155	24	80X120X190	30
40-200	100X120X140	18	100X120X185	24
40-250 A	85X110X120	6	85X110X170	9
40-250 B/C	80X120X120	6	80X120X170	9
50-125	80X120X120	24	80X120X180	24
50-160	100X120X140	18	100X120X185	24
50-200 A	85X110X120	6	85X110X170	9
50-200 B/C	80X120X120	6	80X120X170	9
50-250	80X120X120	6	80X120X170	9
65-125	100X120X140	18	100X120X185	24
65-160	85X110X120	6	85X110X170	9
65-200	85X110X120	6	85X110X170	9
65-250	85X110X130	4	85X110X190	6
80-160	85X110X120	6	85X110X170	9
80-200	85X110X130	4	85X110X190	6



MEC	TYPE	DIMENSIONS (mm)																		
		DNa	DNm	a	h1	h2	m1	m2	n1	n2	b	x	s	C	B	H	I	L		
90	32-160 C	50	32	80	132	160	100	70	240	190	50	12	14	530	240	292	551	250	341	41,5
90	32-160 B	50	32	80	132	160	100	70	240	190	50	12	14	530	240	292	551	250	341	44
90	32-160 A	50	32	80	132	160	100	70	240	190	50	12	14	530	240	292	551	250	341	47
112	32-200 Cm	50	32	80	160	180	100	70	240	190	50	12	14	574	268	340	602	263	395	NA
100	32-200 C	50	32	80	160	180	100	70	240	190	50	12	14	540	268	340	602	263	395	57
132	32-200 B1	50	32	80	160	180	100	70	240	190	50	12	14	520	268	340	627	287	408	65,5
132	32-200 B	50	32	80	160	180	100	70	240	190	50	12	14	565	268	340	627	287	408	73
132	32-200 A1	50	32	80	160	180	100	70	240	190	50	12	14	520	268	340	627	287	408	72,5
132	32-200 A	50	32	80	160	180	100	70	240	190	50	12	14	565	268	340	627	287	408	79,5
132	32-250 C	50	32	100	180	225	125	95	320	250	65	12	14	625	305	405	666	346	471	102
132	32-250 B	50	32	100	180	225	125	95	320	250	65	14	14	625	305	405	666	346	471	105,5
160	32-250 A	50	32	100	180	225	125	95	320	250	65	14	14	695	305	405	810	354	480	135,5
90	40-125 C	65	40	80	112	140	100	70	210	160	50	12	14	535	220	252	551	250	341	41,5
90	40-125 B	65	40	80	112	140	100	70	210	160	50	12	14	535	220	252	551	250	341	44
90	40-125 A	65	40	80	112	140	100	70	210	160	50	12	14	535	220	252	551	250	341	47,5
100	40-160 Bm	65	40	80	132	160	100	70	240	190	50	12	14	535	245	292	551	250	341	56
100	40-160 B	65	40	80	132	160	100	70	240	190	50	12	14	535	245	292	551	250	341	52,5
112	40-160 Am	65	40	80	132	160	100	70	240	190	50	15	14	579	245	292	602	263	395	NA
100	40-160 A	65	40	80	132	160	100	70	240	190	50	15	14	535	245	292	602	263	395	57,5
112	40-160 AP	65	40	80	132	160	100	70	240	190	50	15	14	579	245	292	627	287	408	NA
112	40-200 B1	65	40	100	160	180	100	70	240	190	50	15	14	597	273	340	627	287	408	68
132	40-200 B	65	40	100	160	180	100	70	265	212	50	15	14	590	273	340	627	287	408	75,5
112	40-200 A1	65	40	100	160	180	100	70	240	190	50	15	14	597	273	340	627	287	408	74,5
132	40-200 A	65	40	100	160	180	100	70	265	212	50	15	14	590	273	340	627	287	408	82
132	40-200 AP	65	40	100	160	180	100	70	265	212	50	15	14	628	273	340	666	346	471	NA
132	40-250 C	65	40	100	180	225	125	95	320	250	65	15	14	630	322	405	666	346	471	101
132	40-250 B	65	40	100	180	225	125	95	320	250	65	15	14	630	322	405	666	346	471	105
160	40-250 A	65	40	100	180	225	125	95	320	250	65	15	14	700	322	405	810	354	480	135
132	40-250 BM	65	40	100	180	225	125	95	320	250	65	15	14	750	332	405	810	354	480	150
160	40-250 AM	65	40	100	180	225	125	95	320	250	65	15	14	750	332	405	810	354	480	161
100	50-125 Bm	65	50	100	132	160	100	70	240	190	50	12	14	525	250	292	602	263	395	57,5
100	50-125 B	65	50	100	132	160	100	70	240	190	50	12	14	560	250	292	602	263	395	54
112	50-125 Am	65	50	100	132	160	100	70	240	190	50	12	14	610	250	292	602	263	395	NA
100	50-125 A	65	50	100	132	160	100	70	240	190	50	12	14	560	250	292	602	263	395	58
112	50-160 B1	65	50	100	160	180	100	70	265	212	50	12	14	597	270	340	627	287	408	69
132	50-160 B	65	50	100	160	180	100	70	265	212	50	12	14	590	270	340	627	287	408	75,5
112	50-160 A1	65	50	100	160	180	100	70	265	212	50	12	14	597	270	340	627	287	408	75
132	50-160 A	65	50	100	160	180	100	70	265	212	50	12	14	590	270	340	627	287	408	81,5
132	50-200 C	65	50	100	160	200	100	70	265	212	50	12	14	635	290	360	666	346	471	98,5
132	50-200 B	65	50	100	160	200	100	70	265	212	50	12	14	635	290	360	666	346	471	103
160	50-200 A	65	50	100	160	200	100	70	265	212	50	12	14	705	290	360	810	354	480	132,5
160	50-250 C	65	50	100	180	225	125	95	320	250	65	14	14	705	332	405	810	354	480	140
160	50-250 B	65	50	100	180	225	125	95	320	250	65	14	14	750	332	405	810	354	480	154
160	50-250 A	65	50	100	180	225	125	95	320	250	65	14	14	750	332	405	810	354	480	165
112	65-125 B1	80	65	100	160	180	125	95	280	212	65	14	14	612	280	340	627	287	408	70,5
132	65-125 B	80	65	100	160	180	125	95	280	212	65	14	14	605	280	340	627	287	408	77
112	65-125 A1	80	65	100	160	180	125	95	280	212	65	14	14	612	280	340	627	287	408	76,5
132	65-125 A	80	65	100	160	180	125	95	280	212	65	14	14	605	280	340	627	287	408	83,5
132	65-160 C	80	65	100	160	200	125	95	280	212	65	14	14	635	290	360	666	346	471	100
132	65-160 B	80	65	100	160	200	125	95	280	212	65	14	14	635	290	360	666	346	471	104
160	65-160 A	80	65	100	160	200	125	95	280	212	65	14	14	705	290	360	810	354	480	135
160	65-200 C	80	65	100	180	225	125	95	320	250	65	14	14	705	330	405	810	354	480	140,5
160	65-200 B	80	65	100	180	225	125	95	320	250	65	14	14	750	330	405	810	354	480	153
160	65-200 A	80	65	100	180	225	125	95	320	250	65	14	14	750	330	405	810	354	480	164,5
180	65-250 B	80	65	100	200	250	160	120	360	280	80	16	19	820	370	450	920	420	625	204
180	65-250 A	80	65	100	200	250	160	120	360	280	80	16	19	860	370	450	920	420	625	226
132	80-160 E	100	80	125	180	225	125	95	320	250	65	14	14	665	330	405	810	354	480	110,5
132	80-160 D	100	80	125	180	225	125	95	320	250	65	14	14	665	330	405	810	354	480	114,5
160	80-160 C	100	80	125	180	225	125	95	320	250	65	14	14	735	330	405	810	354	480	143
160	80-160 B	100	80	125	180	225	125	95	320	250	65	14	14	780	330	405	810	354	480	157,5
160	80-160 A	100	80	125	180	225	125	95	320	250	65	14	14	780	330	405	810	354	480	168,5
180	80-200 B	100	80	125	180	250	125	95	345	280	65	16	14	840	355	405	920	420	625	201
180	80-200 A	100	80	125	180	250	125	95	345	280	65	16	14	880	355	405	920	420	625	222
180	100-160 B	125	100	125	200	280	160	120	360	280	80	18	18	842	390	480	920	420	625	208,5
180	100-160 A	125	100	125	200	280	160	120	360	280	80	18	18	882	390	480	920	420	625	230,5