

Monobloc horizontal centrifugal pumps made of stainless steel. Widely used in water supplies, pressurization, cooling, and industrial applications. The pumps guarantee small change in pressure for large flow variation.

Construction features

Pump body	stainless steel AISI 304
Motor bracket	cast iron
Impeller	stainless steel AISI 304
Mechanical seal	ceramic-graphite-NBR
Mechanical seal housing	stainless steel AISI 304
Pump shaft end	stainless steel AISI 304
Liquid temperature	-10 ÷ +90 °C
Operating pressure	max 10 bar

Motor

2 poles induction motor	3~ 230/400V - 50Hz P ≤ 4kW
	3~ 400/690V - 50Hz P > 4kW
	1~ 230V-50Hz
Insulation class	F
Protection degree	IPX5
Motor efficiency	IE3

CMS 32 BE / 1,5 -2E -WF

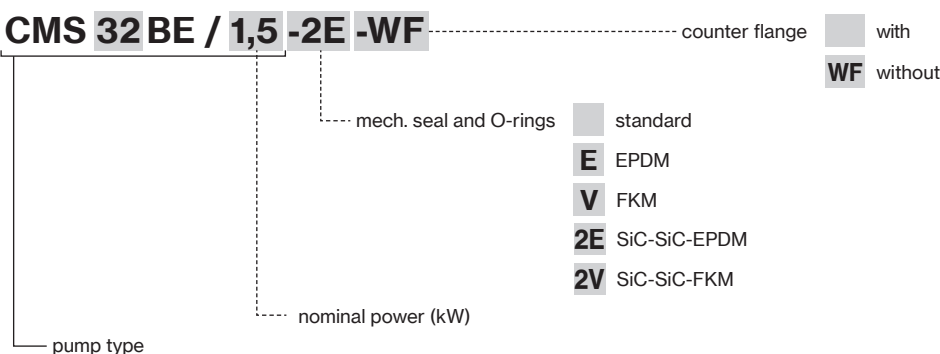

CMS

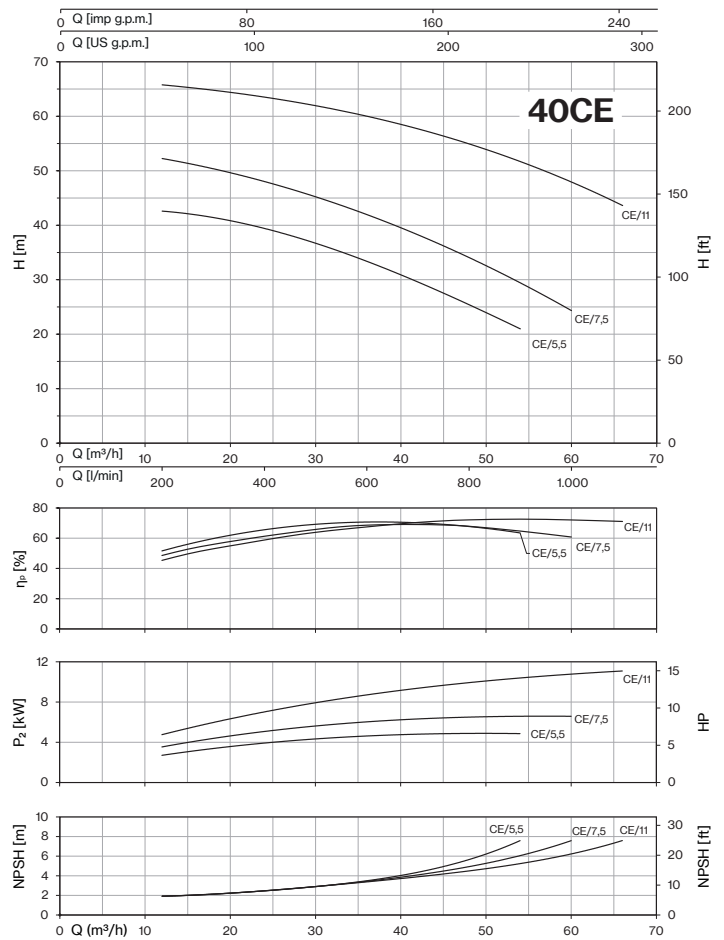
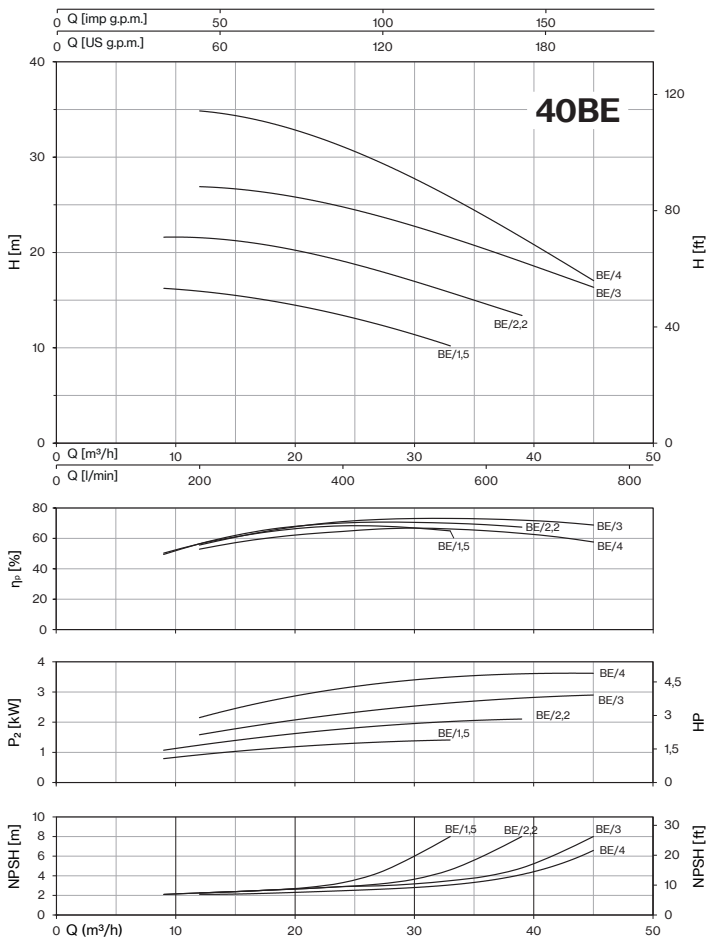
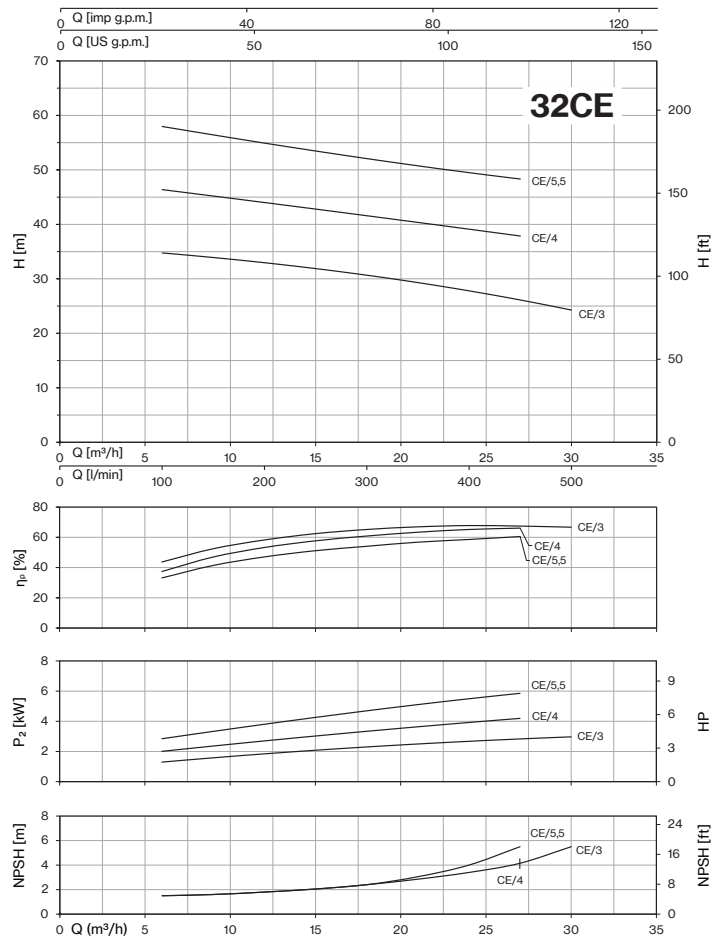
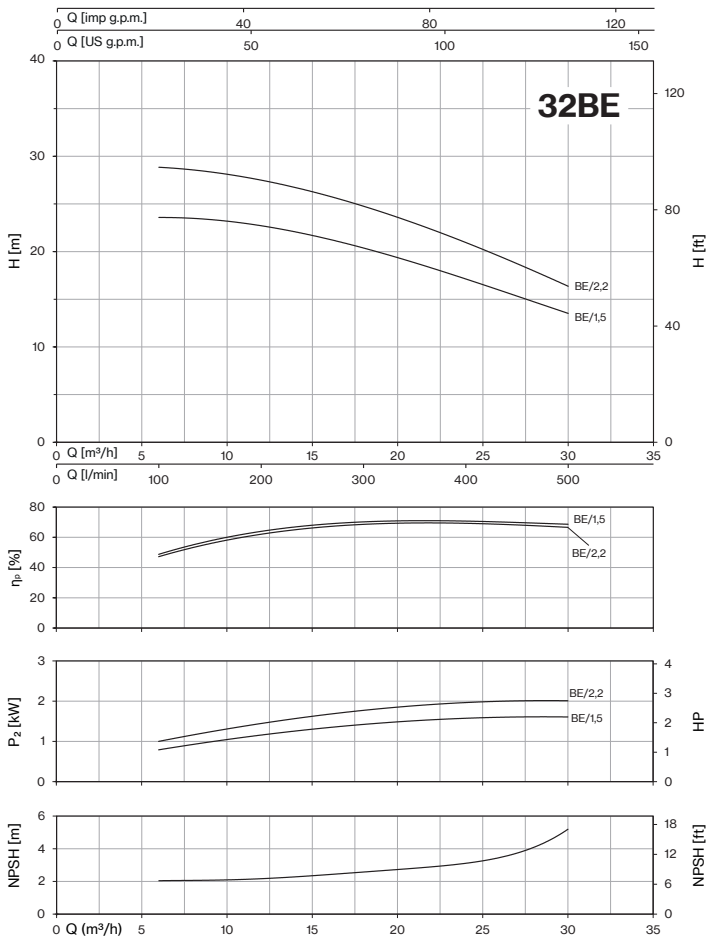

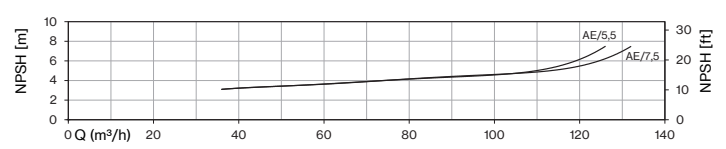
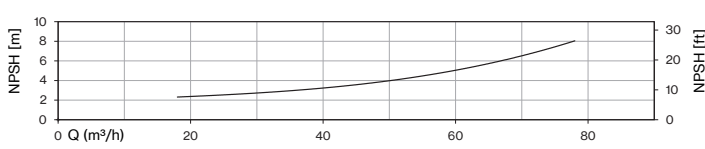
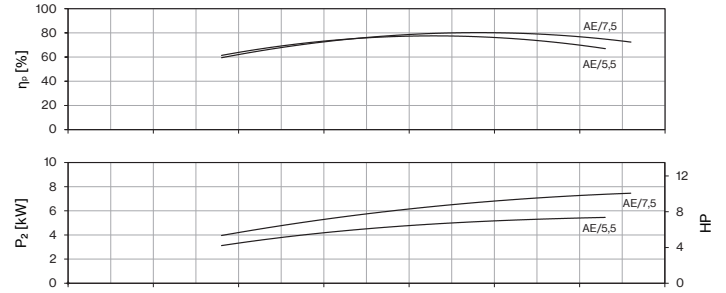
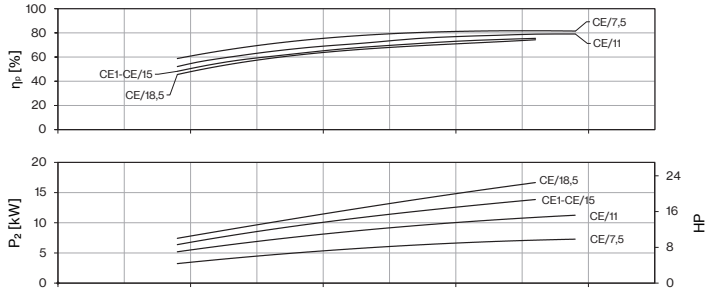
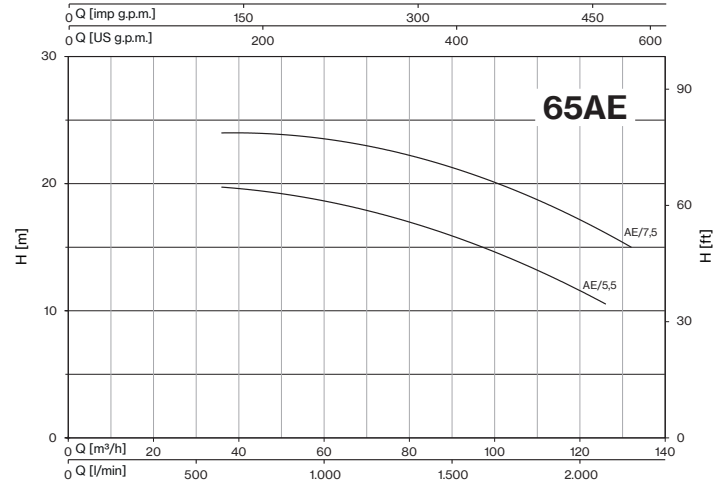
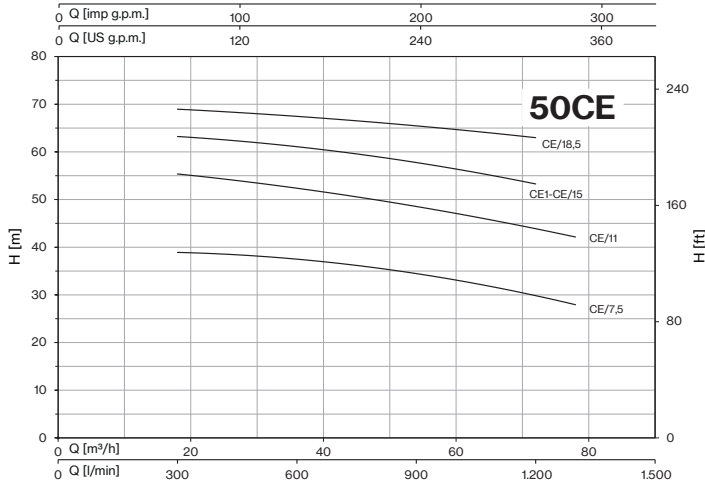
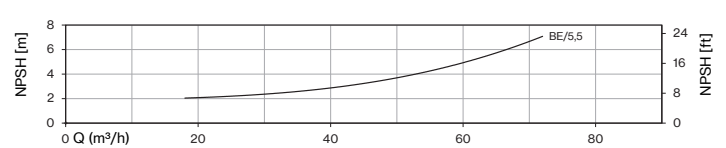
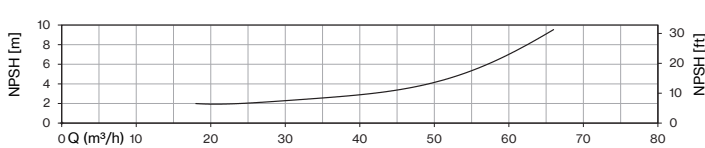
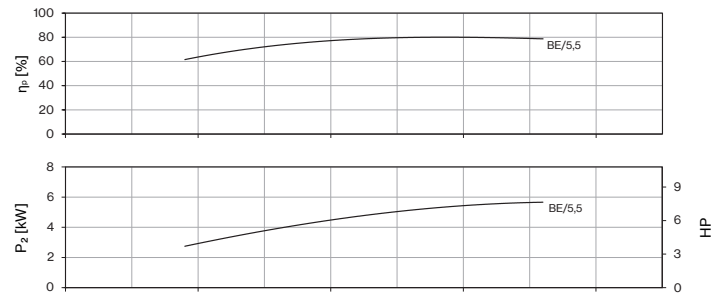
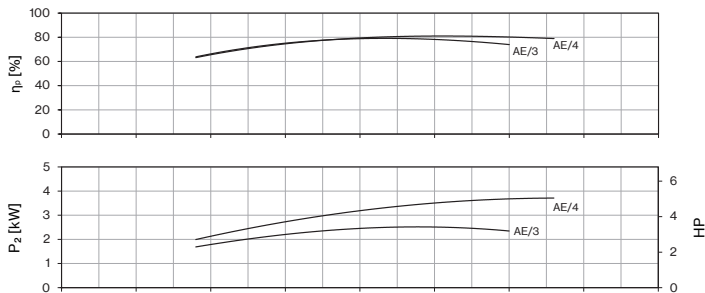
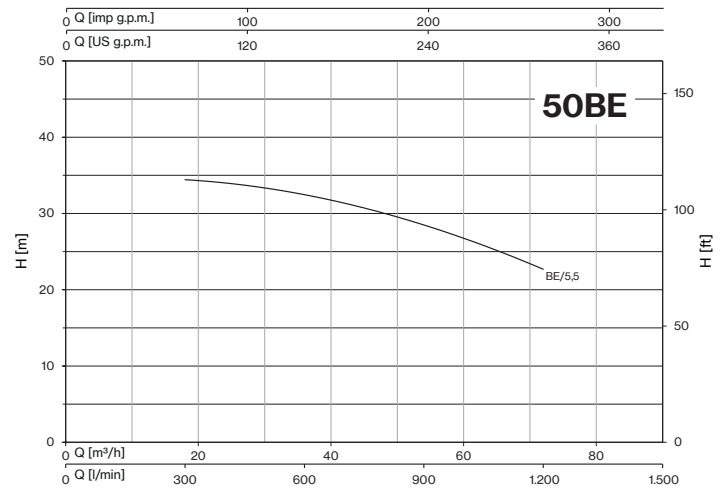
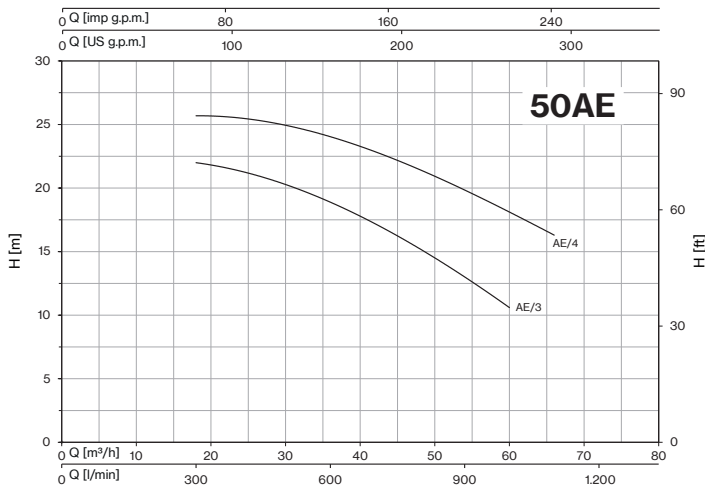

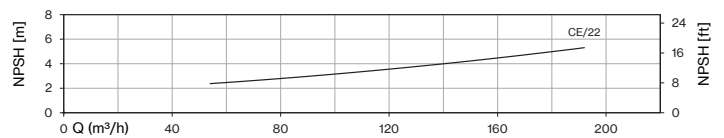
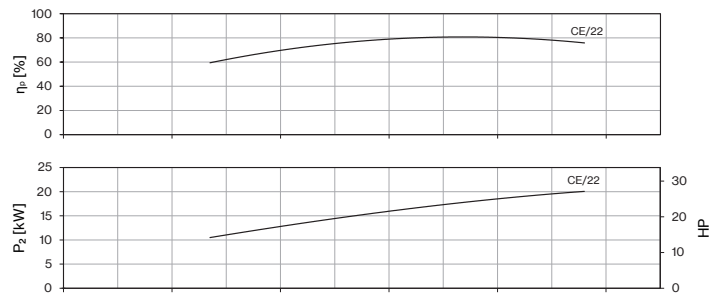
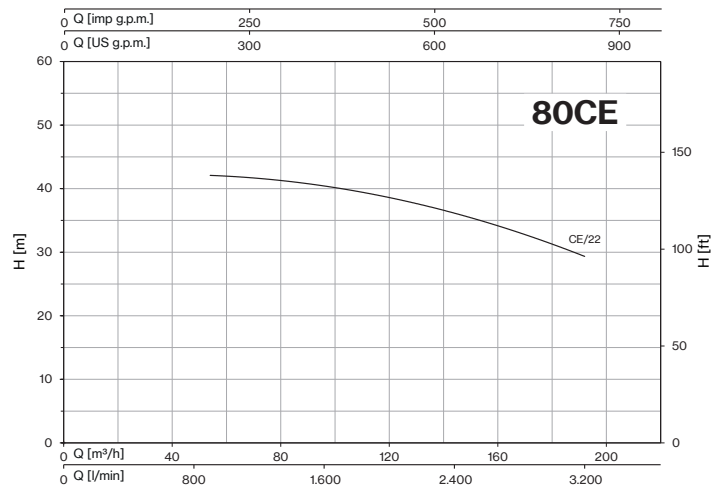
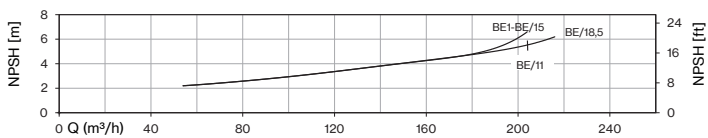
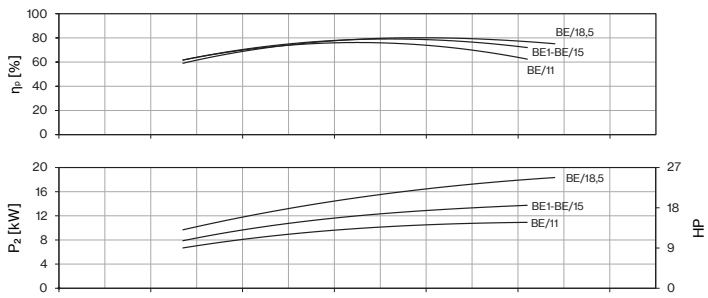
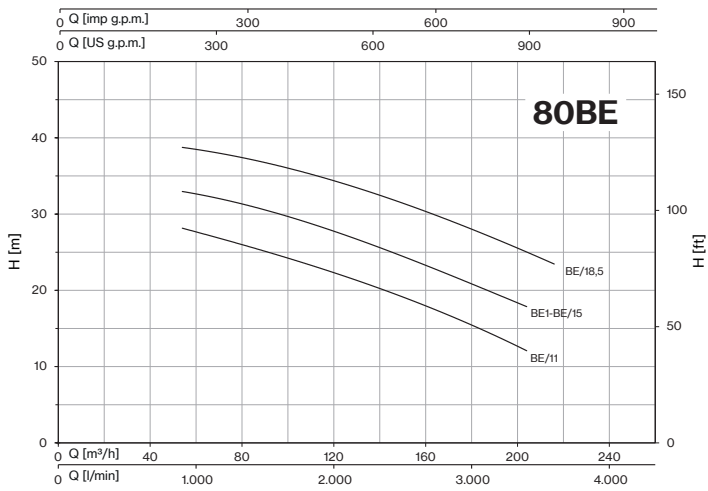
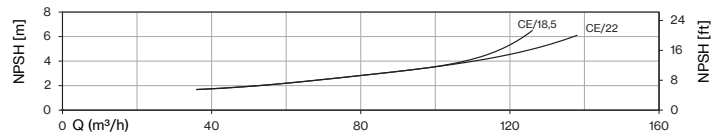
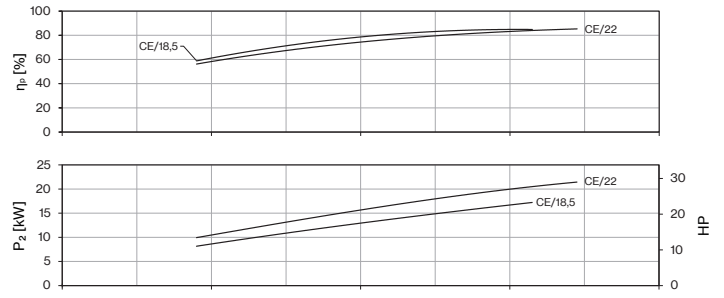
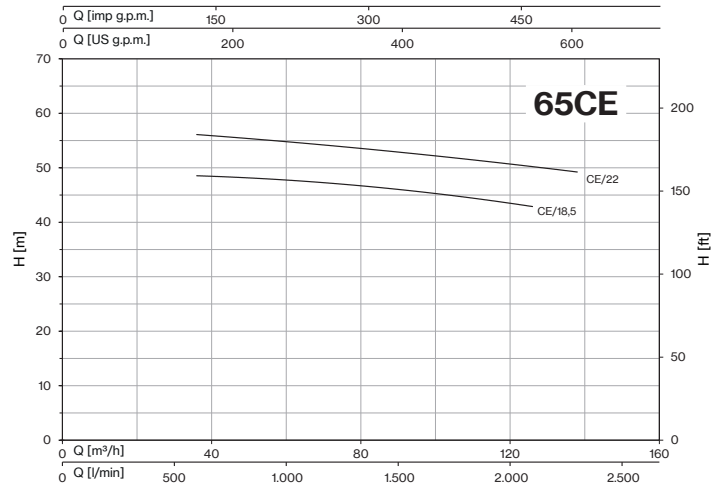
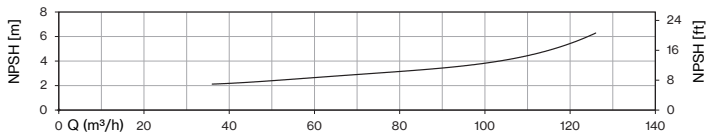
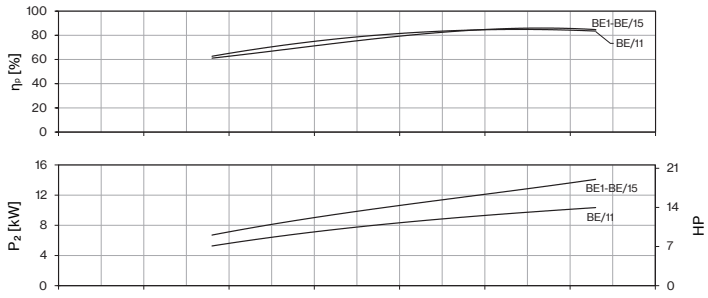
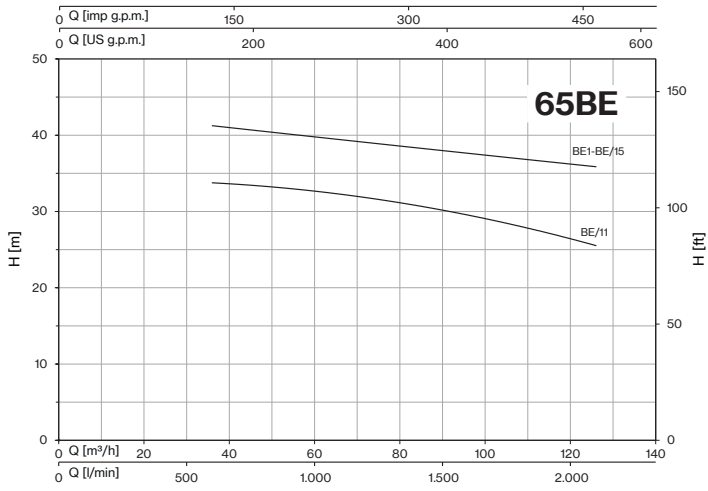

CMS

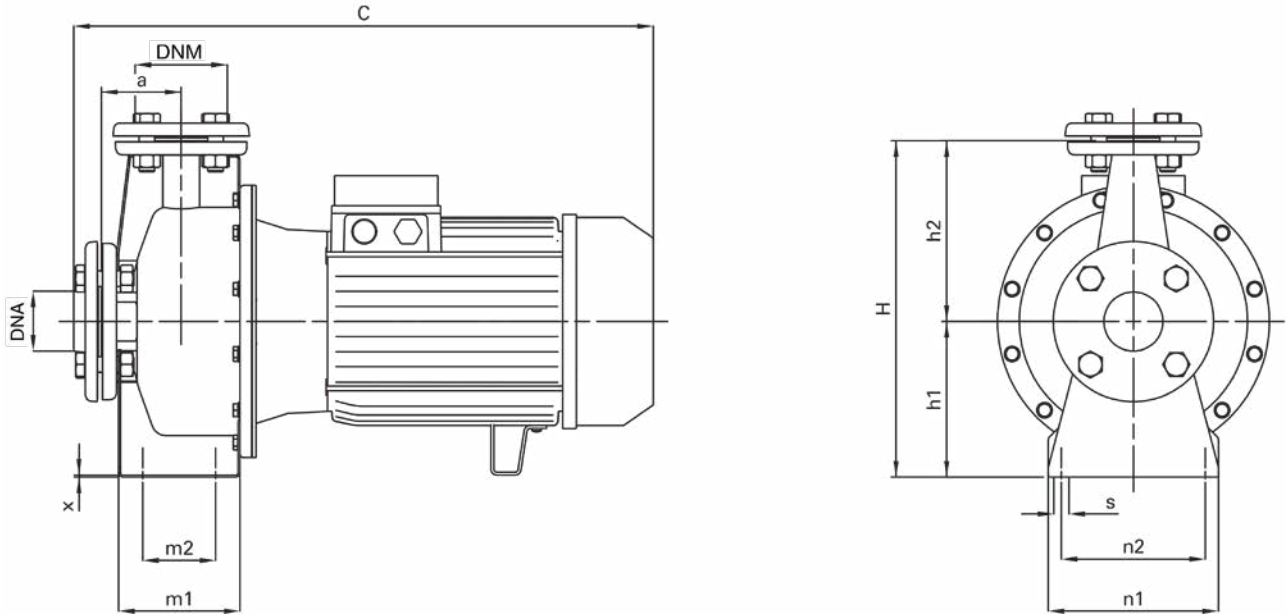



TYPE	DIMENSIONS (mm)																		
	a	h1	h2	m1	m2	n1	n2	x	s	C (1~)	C (3~)	H	DNA	DNM	I	L	M	1~	3~
32BE/1,5	80	132	140	125	75	175	148	2	10	530	530	272	50	32	555	255	345	30,5	29
32BE/2,2	80	132	140	125	75	175	148	2	10	530	530	272			555	255	345	35	31,5
32CE/3	80	160	180	125	75	175	148	2	10	-	535	340			625	310	430	-	37
32CE/4	80	160	180	125	75	175	148	2	10	600	555	340			625	310	430	53	44,5
32CE/5,5	80	160	180	125	75	175	148	2	10	-	600	340			625	310	430	-	53,5
40BE/1,5	80	132	160	125	75	175	148	2	10	535	535	292			65	40	555	255	345
40BE/2,2	80	132	160	125	75	175	148	2	10	535	535	292	555	255			345	35,5	32
40BE/3	80	132	160	125	75	175	148	2	10	-	535	292	555	255			345	-	35,5
40BE/4	80	132	160	125	75	175	148	2	10	595	550	292	555	255			345	51,5	43,5
40CE/5,5	100	160	180	140	93	175	148	2	10	-	615	340	625	310			430	-	54
40CE/7,5	100	160	180	140	93	175	148	2	10	-	615	340	625	310			430	-	60
40CE/11	100	160	180	140	93	175	148	2	10	-	645	340	670	350	525	-	83,5		
50AE/3	100	132	160	125	75	175	148	2	10	-	535	292	65	50	555	255	345	-	36
50AE/4	100	132	160	125	75	175	148	2	10	600	555	292			555	255	345	52	43,5
50BE/5,5	100	160	180	140	93	175	148	2	10	-	615	340			625	310	430	-	54
50CE/7,5	100	160	200	140	93	175	148	2	10	-	615	360			625	310	430	-	60
50CE/11	100	160	200	140	93	175	148	2	10	-	645	360			670	350	525	-	83,5
50CE/15	100	160	200	140	93	175	148	2	10	-	690	360			820	360	525	-	88
50CE/18,5	100	160	200	140	93	175	148	2	10	-	725	360	820	360	525	-	115		
65AE/5,5	100	160	180	140	93	175	148	2	10	-	615	340	80	65	625	310	430	-	53,5
65AE/7,5	100	160	180	140	93	175	148	2	10	-	615	340			625	310	430	-	59,5
65BE/11	100	160	200	140	93	175	148	2	10	-	645	360			670	350	525	-	85
65BE/15	100	160	200	140	93	175	148	2	10	-	690	360			820	360	525	-	89
65BE/15	100	160	200	140	93	175	148	2	10	-	725	360			820	360	525	-	116
65CE/18,5	100	180	225	140	93	175	148	2	10	-	770	405			820	360	525	-	130,5
65CE/22	100	180	225	140	93	175	148	2	10	-	770	405	820	360	525	-	141		
80BE/11	125	180	225	167	93	175	148	2	10	-	685	405	100	80	820	360	525	-	87
80BE/15	125	180	225	167	93	175	148	2	10	-	730	405			820	360	525	-	91
80BE/15	125	180	225	167	93	175	148	2	10	-	765	405			820	360	525	-	118
80BE/18,5	125	180	225	167	93	175	148	2	10	-	810	405			870	400	570	-	132,5
80CE/22	125	180	250	167	93	175	148	2	10	-	810	430			870	400	570	-	143

CMS Serie-Mechanical seal and bearings

MECHANICAL SEAL	PUMP MODEL	SHAFT Ø		STANDARD MATERIAL	OPTIONAL			
					E	V	2E	2V
	32BE/1,5 - 32BE/2,2 - 32CE/3 - 40BE/1,5 - 40BE/2,2 - 40BE/3 - 50AE/3	20mm	Rotating face Stationary face Elastomer	Ceramic Graphite NBR	Ceramic Graphite EPDM	- - -	SiC SiC EPDM	SiC SiC FKM
	32CE/4 - 32CE/5,5 - 40BE/4 - 40CE/5,5 - 40CE/7,5 - 40CE/11 - 50AE/4 - 50BE/5,5 - 50CE/7,5 - 50CE/11 - 50CE/15 - 50CE1/15 - 50CE/18,5 - 65AE/5,5 - 65AE/7,5 - 65BE/11 - 65BE1/15 - 65BE/15 - 65CE/18,5 - 65CE/22 - 80BE/11 - 80BE1/15 - 80BE/15 - 80BE/18,5 - 80CE/22	28mm	Rotating face Stationary face Elastomer	Ceramic Graphite NBR	Ceramic Graphite EPDM	Ceramic Graphite FKM	SiC SiC EPDM	SiC SiC FKM

BEARINGS	PUMP MODEL	TYPE	
	32CE/4 - 40BE/4 - 50AE/4	6204-ZZ	6206-ZZ C3
	32BE/1,5 - 32BE/2,2 - 32CE/3 - 40BE/1,5 - 40BE/2,2 - 40BE/3 - 50AE/3	6205-ZZ C3	6203-ZZ
	1- 32CE/4 - 32CE/5,5 - 1- 40BE/4 - 40CE/5,5 - 40CE/7,5 - 1- 50AE/4 - 50BE/5,5 - 50CE/7,5 - 65AE/5,5 - 65AE/7,5	6206-ZZ C3	6306-ZZ C3
	40CE/11 - 50CE/11 - 65BE/11 - 80BE/11	6206-ZZ C3	6308-ZZ C3
	65BE1/15 - 50CE1/15 - 80BE1/15	6308-ZZ C3	6306-ZZ C3
	50CE/15 - 50CE/18,5 - 65BE/15 - 65CE/18,5 - 65CE/22 - 80BE/15 - 80BE/18,5 - 80CE/22	6308-ZZ C3	6309-ZZ C3