

SERIES  
**KTV**

SUBMERSIBLE LIGHTWEIGHT  
DEWATERING PUMPS



# Submersible Lightweight Compact Dewatering Pumps

Tsurumi KTV-series features submersible pumps of lightweight compact design. The pump body is made of die-casted aluminium alloy, which is extremely advantageous in terms of portability. The sleeves that protect the pump casing, oil casing and water passages are made of synthetic rubber as a consideration against wear. With the exception of the 0.75kW models, all models of the KTV-series are equipped with a protection plate to prevent damage to the oil casing. The impeller is of semi-vortex design that considerably reduces performance drop caused by wear. As such, these Tsurumi pumps provide excellent reliability and durability that enable continuous duty for long periods of time.

The KTVE-series features automatic pumps without cumbersome floats. An innovative electrode type relay unit built into the pump automatically starts and stops the pump to eliminate dry-running. This mechanism greatly reduces power consumption and extends operating life. Also available is the KTV (slurry)-series that Tsurumi equips with an agitator for slurry dewatering.

Tsurumi's pumps have been widely adopted in various fields from civil engineering and construction to large-scale construction projects (tunnels, bridges, dams, etc.) where the pumps must perform reliably in severe environments.



**KTV:** Drainage pumps of lightweight compact design

**KTVE:** Automatic drainage pumps with an innovative electrode type relay unit

**KTV (Slurry):** Slurry pumps that deliver powerful agitation for discharging slurries laden with silt, earth, sand or other particulate

## Selection Table

Motor Output		0.75kW	1.5kW	2-2.2kW	3-3.7kW	5.5kW
KTV	2" 50mm					
	3" 80mm					
KTVE -Automatic-	2" 50mm					
	3" 80mm					
KTV -Slurry-	2" 50mm					
	3" 80mm					

**KTV**  
Drainage Pumps



**KTVE**  
Automatic Drainage Pumps



**KTV**  
(Slurry)  
Slurry Pumps



mayitaly.vn

## Top Discharge, Side Flow Design

This design assures efficient motor cooling even if the pump runs with its motor exposed to air, and also allows the overall diameter of the pump to be reduced for installation in confined spaces.

Model  
**KTVE33.7**

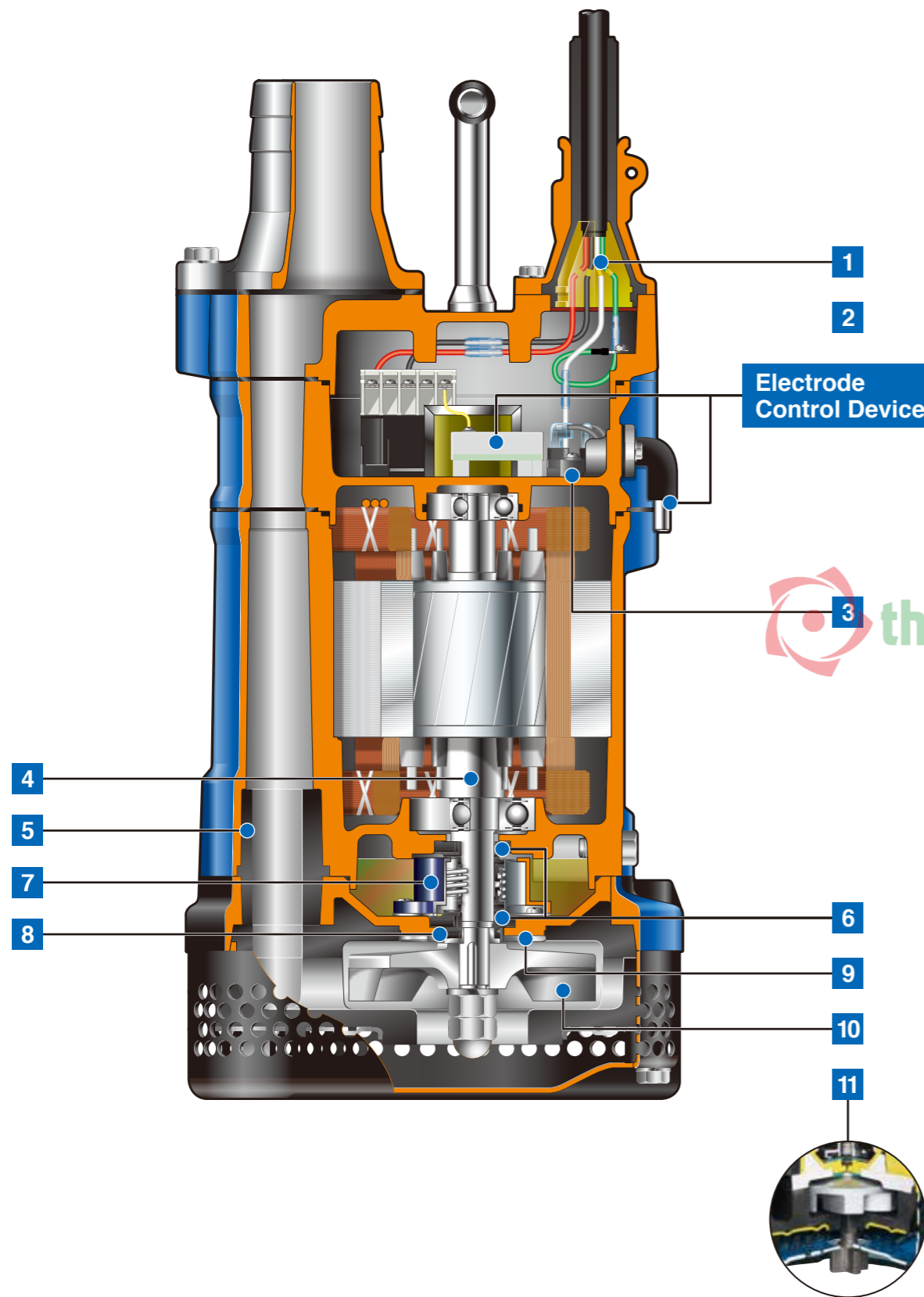

### Electrode Control Device (KTVE)

Consisting of an electric probe and relay unit, this enables automatic operation, reduces power consumption and extends operating life.

### 1 Anti-wicking Cable Entry

Prevents water incursion due to capillary action should the cable sheath be damaged or the end of cable submerged. Also prevents moist air from infiltrating the motor housing and condensation from forming inside the housing due to temperature differences between the housing and outside air.

### 2 Cable Clip

Prevents unexpected water incursion that can occur if the cable is damaged, by protecting the cable against the tugging and rough handling found at construction sites.

### 3 Circle Thermal Protector

Directly cuts the motor circuit if excessive heat builds up or overcurrent occurs in the motor.

### 4 Shaft

Made of a solid material (without welds) of thoroughly proven bending strength and tensile strength.

### 5 Die-casted Aluminium Alloy Body & Wear-resistant Synthetic Rubber

Provide a great advantage in terms of portability. The pump body is made of die-casted aluminium alloy. The sleeves that protect the pump casing, oil casing and water passages are made of synthetic rubber, thus eliminating worries about durability and wear.

### 6 Dual Inside Mechanical Seals with Silicon Carbide Faces

Isolated in the oil chamber where a clean, non-corrosive and abrasion-free lubricating environment is maintained. Compared with the water-cooled outside mechanical seal, it reduces the risk of failure caused by dry-heating and adhering matter. The silicon carbide provides 5 times higher corrosion, wear and heat resistance than the tungsten carbide. Rubber parts of the upper and lower fixing rings are made of NBR or FPM (FKM), which provides higher resistance to heat and chemicals.

### 7 Oil Lifter

Provides lubrication and cooling of the seal faces down to 1/3 of normal oil level, thus maintaining a stable shaft sealing effect and prolonging seal life longer. The Oil Lifter is Tsurumi original design.

### 8 V-ring

Used as a "Dust Seal", it protects the mechanical seal from abrasive particles.

### 9 Protection Plate (excluding 0.75kW)

Protect the oil casing made of aluminium alloy die casting from abrasive particles.

### 10 Urethane Rubber or Ductile Cast Iron Semi-vortex Impeller (KTV & KTVE)

**High-chromium Cast Iron Semi-vortex Impeller (KTV -Slurry-)**  
Resists wear caused by abrasive particles and enables the pump to maintain its original performance for an extended period of time.

### 11 Agitating Mechanism (KTV -Slurry-)

Consists of a shaft-mounted agitator and a dedicated strainer. The agitator made of ductile cast iron resists wear caused by abrasive particles, and it suspends solids to assist in pumping sediments in combination with the strainer.



# Automatic Drainage Pumps with Electrode Control Device

Contributing to reduction of power consumption, prevention of dry-running and extension of operating life.



KTVE

## Automatic Operation

I

Pump continues to run while the electric probe remains submerged.

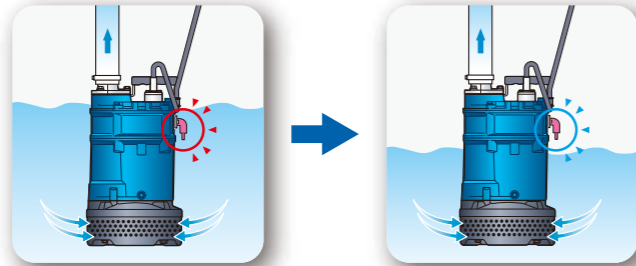

II

When the water surface falls below the electric probe, timer starts to count about one minute.



IV

When the water level rises to contact the electric probe, pump starts operating again.

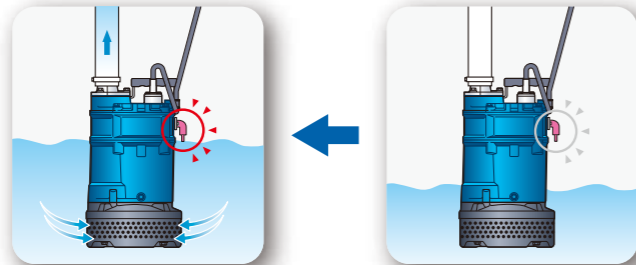

III

Pump stops in about one minute after the water level falls.



The process is repeated.

## 40 % Reduction in Power Consumption

### Electrode Control Device

Tsurumi has developed a unique automatic control device utilizing an electrode. It consists of an electric probe and relay unit. When the water level rises to contact the electric probe, electric continuity is produced between the electrode and the pump body, and the relay unit built into the pump turns on the pump.

The relay unit includes a timer function. The pump stops automatically in about one minute after the water surface falls below the electric probe. If the water level rises again to contact the electric probe within the run time, the pump continues to run for one more minute.

Since this mechanism eliminates dry-running, the pump can reduce power consumption by up to 40 percent compared with non-automatic pumps (Tsurumi comparison). It also prevents chattering caused by a turbulent water surface and extends operating life.

It is possible to set a lower starting water level by using an extension probe (optional accessory). The starting water level is adjustable because the extension probe can be cut to the desired length as it is made of coil spring.

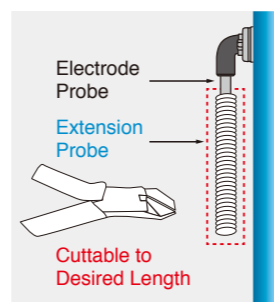
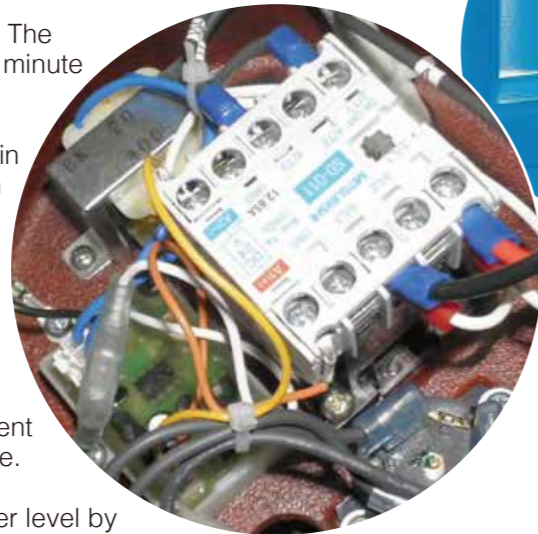

## Example of use of automatic pumps in an underground car park

Simply connect the pumps to a power supply for automatic operation.

By setting up multiple Tsurumi automatic pumps at different height levels, these pumps prevent damage caused by submersion in flood water resulting from heavy rain. These pumps do not require any complex setting or installation work. Installation is as easy as positioning the pumps and connecting them to a power supply. If flooding occurs and the water level increases, the pumps automatically start pumping out water.

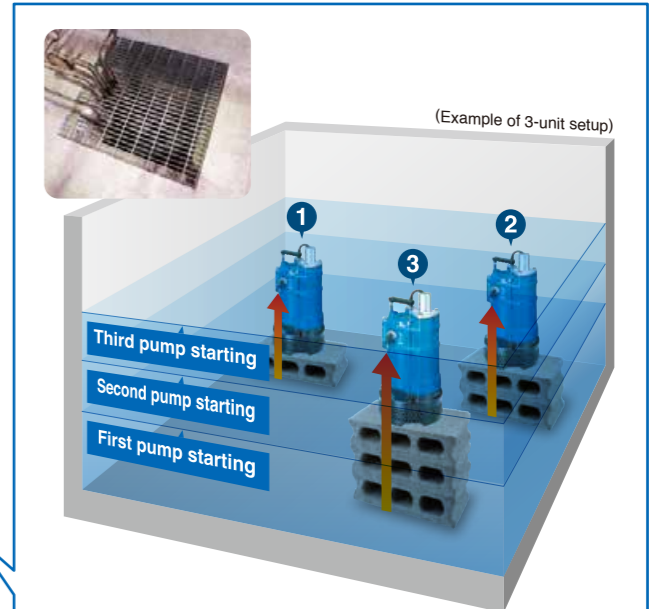

### Adjusting the start water level by setting up multiple automatic pumps

The pumps automatically start pumping out water when the water level rises, and also automatically stop when the water level decreases. Simply raise or lower the pump position using blocks or bricks to set the water level at which the pump starts operation.

For an underground car park where flood water may enter, Tsurumi automatic pumps can effectively prevent damage caused by submersion.



## Drainage pumps of lightweight compact design

The KTV-series is a submersible three-phase portable drainage pump. Though it is a three-phase unit, the pump is designed to weigh lighter for portability, yet it can be used for pumping liquid found in ordinary construction and foundation works. The top discharge, side flow design assures efficient motor cooling even when it operates with its motor exposed to air. The slim design allows the pump to be placed in a confined space.



## Automatic drainage pumps with an innovative electrode type relay unit

The KTVE-series is a submersible three-phase automatic portable drainage pump. An innovative electrode type relay unit built into the pump automatically starts and stops the pump to eliminate dry-running. This mechanism greatly reduces power consumption and extends operating life. Though the pump is a three-phase unit, it is designed to weigh lighter for portability, yet it can be used for pumping liquid found in ordinary construction and foundation works. The top discharge, side flow design assures efficient motor cooling even when it operates with its motor exposed to air. The slim design allows the pump to be placed in a confined space.



### Performance Curves

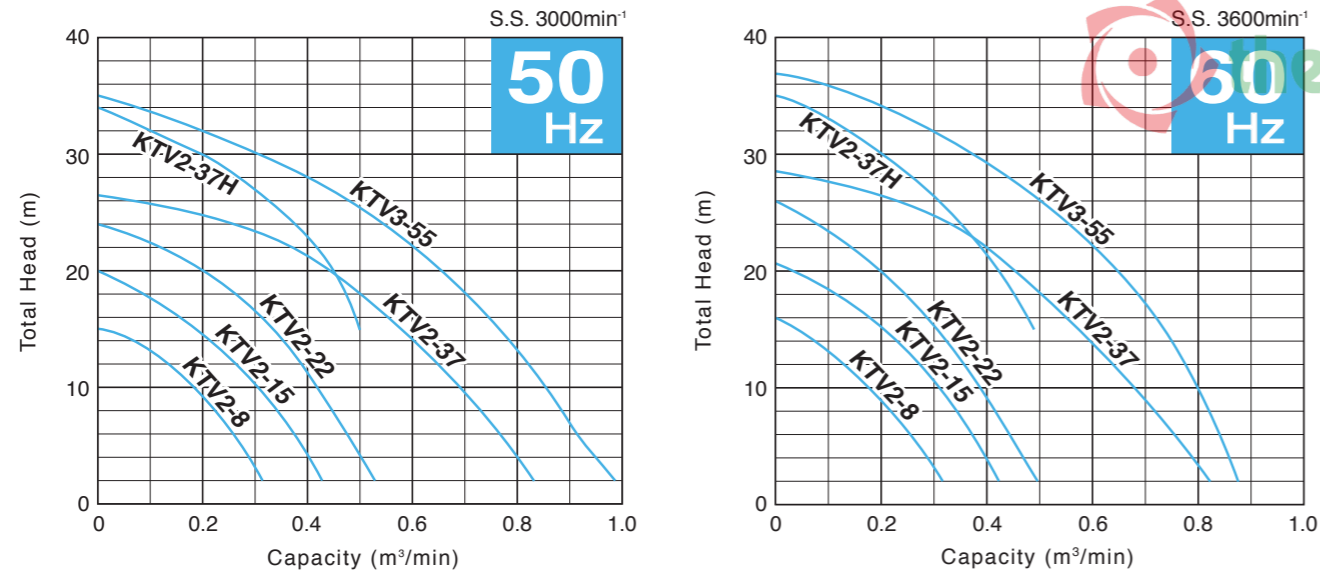

Discharge Bore mm	Model	Motor Output kW	Phase	Starting Method	Solids Passage mm	Dimensions L x H mm	Dry Weight*² kg	Cable Length m
50	KTV2-8	0.75	Three	D.O.L.	8.5	200 x 369	11.5	5
50 (80)*¹	KTV2-15	1.5		D.O.L.	8.5	240 x 396	21	8
50 (80)*¹	KTV2-22	2.2		D.O.L.	8.5	240 x 416	23	8
50	KTV2-37H	3.7		D.O.L.	8.5	285 x 510	36	8
80 (100)*¹	KTV2-37	3.7		D.O.L.	8.5	285 x 510	36	8
80 (100)*¹	KTV3-55	5.5		D.O.L.	8.5	300 x 545	47	8

\*¹ Discharge bore in parentheses available upon request

\*² Weights excluding cable

### Performance Curves

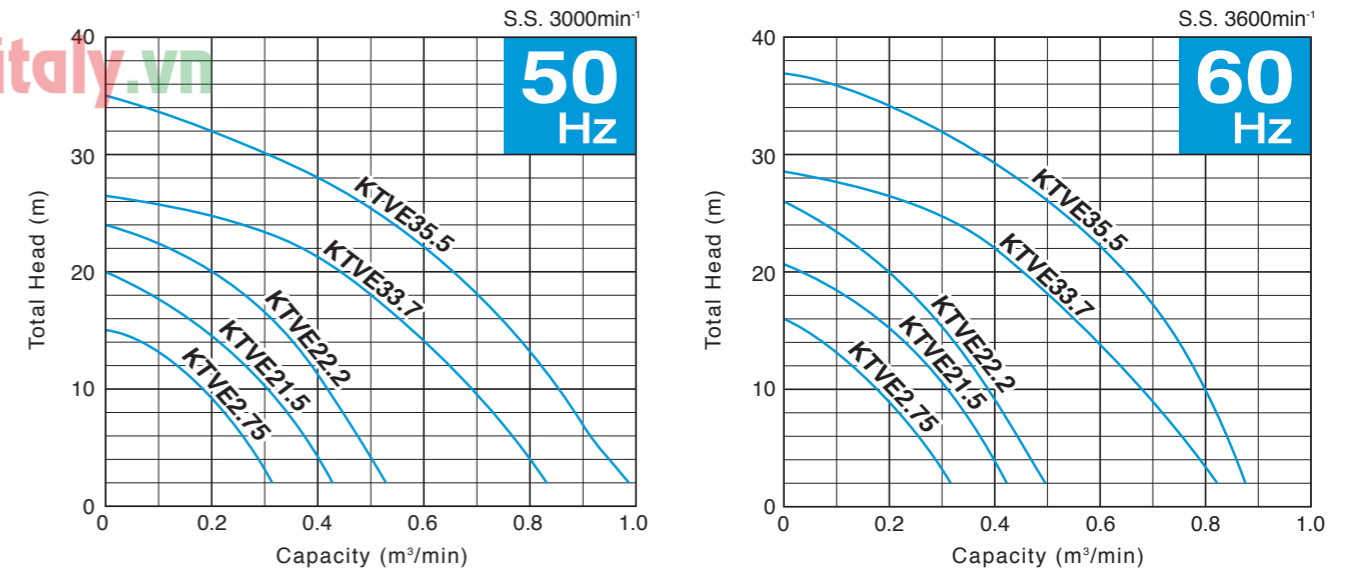

Discharge Bore mm	Model	Motor Output kW	Phase	Starting Method	Solids Passage mm	Dimensions L x H mm	Dry Weight*² kg	Cable Length m
50	KTVE2.75	0.75	Three	D.O.L.	8.5	200 x 417	12.7	5
50 (80)*¹	KTVE21.5	1.5		D.O.L.	8.5	240 x 462	21.5	8
50 (80)*¹	KTVE22.2	2.2		D.O.L.	8.5	240 x 462	24.5	8
80 (100)*¹	KTVE33.7	3.7		D.O.L.	8.5	285 x 585	39.5	8
80 (100)*¹	KTVE35.5	5.5		D.O.L.	8.5	300 x 620	52	8

\*¹ Discharge bore in parentheses available upon request

\*² Weights excluding cable

# KTV -Slurry-

## Slurry pumps that deliver powerful agitation for discharging slurries laden with silt, earth, sand or other particulate

The KTV-series of slurry-handling type is a submersible three-phase portable slurry pump. It is equipped with an agitator that assists smooth suction of the settled matters. Though the pump is a three-phase unit, it is designed to weigh lighter for portability, yet it can be used for pumping slurry. The pump parts such as the impeller and the pump casing are made of wear-resistant materials. The top discharge, side flow design assures efficient motor cooling even when it operates with its motor exposed to air. The slim design allows the pump to be placed in a confined space.



### Performance Curves

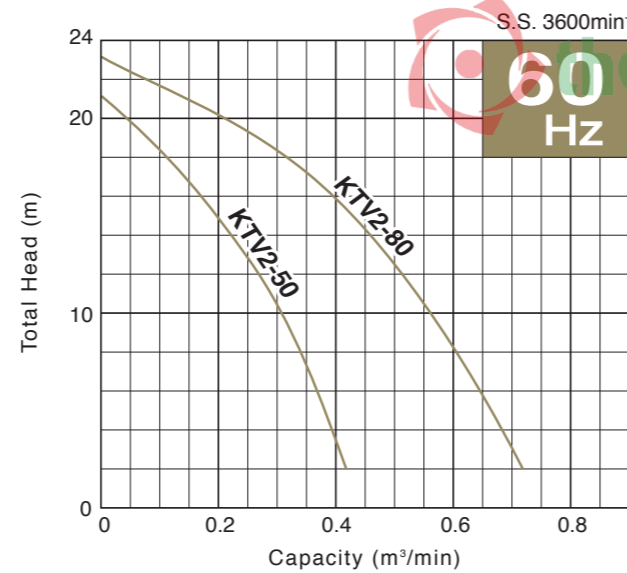
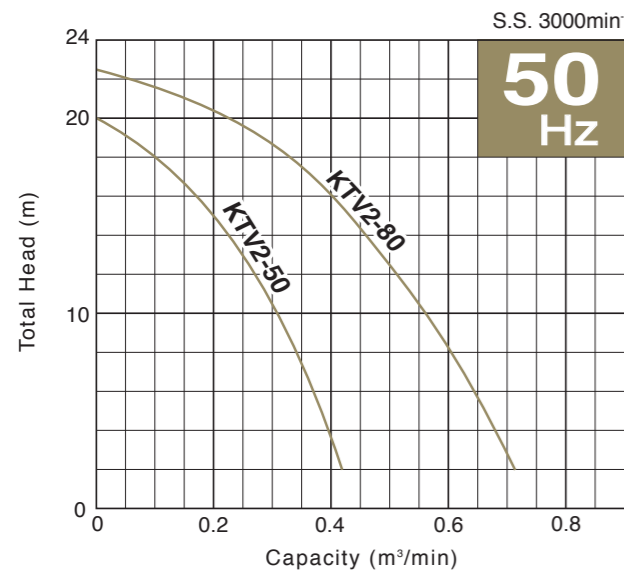

Discharge Bore mm	Model	Motor Output kW	Phase	Starting Method	Solids Passage mm	Dimensions L x H mm	Dry Weight* <sup>2</sup> kg	Cable Length m
50 (80)* <sup>1</sup>	<b>KTV2-50</b>	2	Three	D.O.L.	8.5	250 x 453	25	8
80 (100)* <sup>1</sup>	<b>KTV2-80</b>	3		D.O.L.	8.5	295 x 550	38	8

\*<sup>1</sup> Discharge bore in parentheses available upon request

\*<sup>2</sup> Weights excluding cable

## Specifications

	KTV						KTVE					KTV(Slurry)	
	KTV 2-8	KTV 2-15	KTV 2-22	KTV 2-37H	KTV 2-37	KTV 3-55	KTVE 2.75	KTVE 21.5	KTVE 22.2	KTVE 33.7	KTVE 35.5	KTV 2-50	KTV 2-80
Discharge Bore mm	50	50 (80)* <sup>1</sup>	50	80 (100)* <sup>1</sup>	50	80 (100)* <sup>1</sup>	50	50 (80)* <sup>1</sup>	80 (100)* <sup>1</sup>	80 (100)* <sup>1</sup>	50 (80)* <sup>1</sup>	80 (100)* <sup>1</sup>	
Discharge Connection	Hose Coupling												
Solids Passage mm	8.5												
Impeller	Semi-vortex												
	Urethane Rubber	Ductile Cast Iron					Urethane Rubber	Ductile Cast Iron				High-chromium Cast Iron	
V-ring	Nitrile Butadiene Rubber												
Protection Plate	—	304 Stainless Steel					—	304 Stainless Steel					
Casing	Butadiene Rubber + Natural Rubber												
Shaft Seal	Dual Inside Mechanical Seals (with Oil Lifter)												
	Silicon Carbide												
Agitator	—											Ductile Cast Iron	
Type	Continuous-duty Rated, Dry-type Induction Motor												
Output kW	0.75	1.5	2.2	3.7	5.5	0.75	1.5	2.2	3.7	5.5	2	3	
Phase	Three												
Pole	2												
Insulation	E												
Starting Method	D.O.L.												
Motor Protector (built-in)	CTP												
Lubricant ml	150	270	400	680	150	270	400	680	270	400			
	Turbine Oil (ISO VG32)												
Frame	Die-casted Aluminium Alloy												
Shaft	420 Stainless Steel	403 Stainless Steel					420 Stainless Steel	403 Stainless Steel					
Cable m	5	8				5	8						
	PVC			Chloroprene Rubber			PVC		Chloroprene Rubber		PVC	Chloroprene Rubber	
Automatic Control Device	—						Electrode					—	
Dry Weight* <sup>2</sup> kg	11.5	21	23	36	47	12.7	21.5	24.5	39.5	52	25	38	

\*<sup>1</sup> Discharge bore in parentheses available upon request

\*<sup>2</sup> Weights excluding cable



Product images and specifications may differ from actual products due to improvements. The OO series and model OO are indicated with our series/model codes in this catalog.

**TSURUMI  
MANUFACTURING CO., LTD.**

Your Dealer